

A.C. INDUCTION MOTORS - 50Hz

Zirantec



www.zirantec.com



FABBRICA ITALIANA POMPE SOMMERSIBILI S.r.l.

Zirantec



ZIRANTEC products are manufactured by well qualified and experienced Italian Pump Engineers in state of the art manufacturing facilities in Italy

CERTIFICATION



ZIRANTEC Pumps & Motors are from the house of **Fabbrica Italiana Pompe Sommergeibili S.r.l.** a four decades old Italian company of high repute, offering complete waste water solutions around the world. Its current product portfolio includes world class Waste Water Pumps of various types, Multistage Centrifugal Pressure Booster Pumps, Borehole Submersible Pumps & Motors, End Suction Centrifugal Pumps, Industrial Pumps for various applications.

Founded as early as 1978 in Rozzano, South of Milan, Italy by Mr.Orfeo Agostini, the company has witnessed steady growth and market expansion continuously ever since. In these four decades of existence, the company has carved a niche for itself in the waste water and sewage pump market in Italy and other countries. Its products are employed in Municipal, Domestic and Industrial applications. The Company is well known for the unique and robust designs of its products and their workmanship. Due to its superior quality ZIRANTEC products are also exported to many European, African and Asian countries.

ZIRANTEC's products are conceived, designed and manufactured by well qualified and experienced Italian Pump Engineers in state of the art manufacturing facilities in Italy. These manufacturing plants are accredited with UNI EN ISO 9001:2008 Certification.

Over the years, the company has metamorphosed and ventured into manufacturing of high quality water pumps, for domestic, agricultural and industrial applications. In the due process, Fabbrica Italiana Pompe Sommergeibili S.r.l. has shed its image of an exclusive sewage and waste water pumps manufacturer to a complete pump production company with an ability to manufacture diverse kinds of pumps for different applications.

C O N T E N T S

A.C. INDUCTION MOTORS - 50Hz	PageNo.
MODEL IDENTIFICATION CODE	3
DESCRIPTION & APPLICATION & MOC	4
TECHNICAL SPECIFICATIONS & EXPLODED VIEW	5
IE 1 MOTORS	6 -7
IE 2 MOTORS	8
IE 3 MOTORS	9
DIMENSIONAL DETAILS	10
SHAFT, SHAFT KEY DIMENSIONS & DEGREE OF PROTECTION DETAILS	11
MOUNTING ARRANGEMENTS & ELECTRICAL PARAMETERS	12 - 15

MODEL IDENTIFICATION CODE

F.A.C. INDUCTION MOTOR - 50Hz

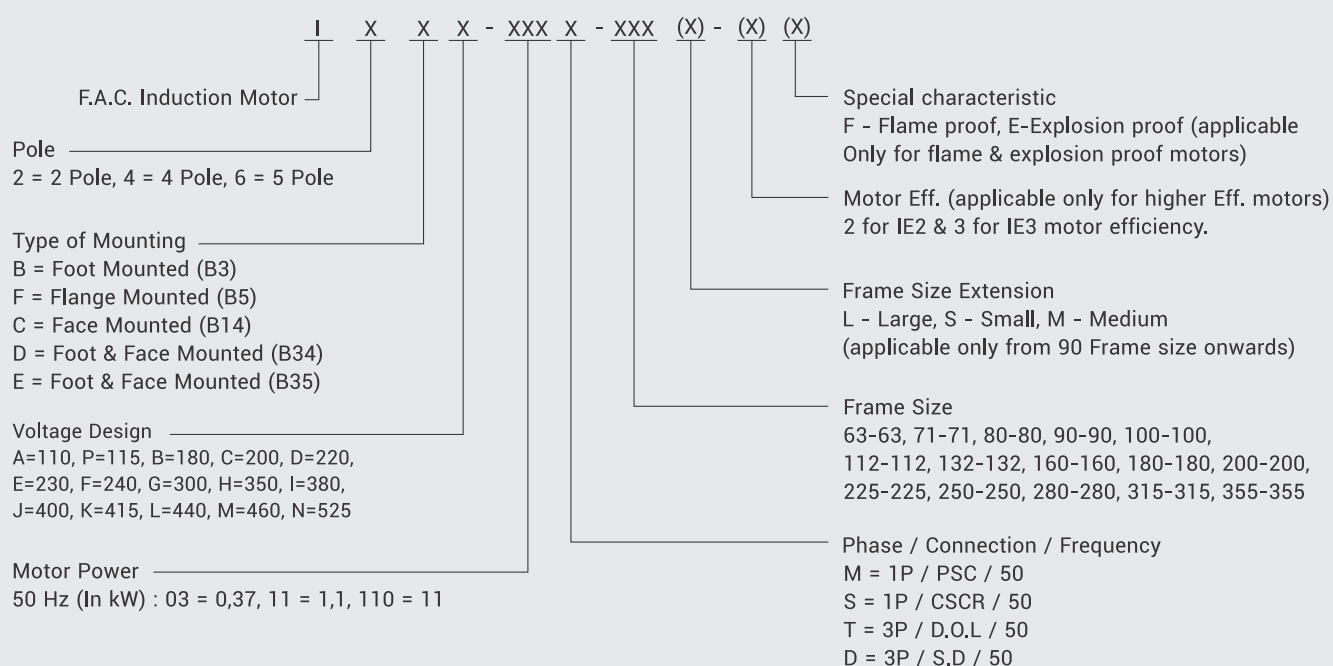

Description :

Foot / Face Mounted Type

Single Phase : I2BE-11M-80, 1,1 kW, 50 Hz, 230 V, 1 Ph, Foot Mounted A.C. Induction Motor.

Three Phase : I2CI-150T-90, 15 kW, 50 Hz, 380 V, 3 Ph, DOL, Face Mounted A.C. Induction Motor.

Flange Mounted Type

Single Phase: I4FE-11M-80-2, 1,1 kW, 50 Hz, 230 V, 1 Ph, IE2, Flange Mounted A.C. Induction Motor.

Note : Flame proof & High Tension motors can be supplied on requirements.

* In view of continuous development, the information / descriptions / specifications / illustrations are subject to change without notice.

GENERAL INFORMATION



ZIRANTEC offers a comprehensive range of A.C. Induction motors in standard and premium efficiency designs for wide range of applications. These motors are synchronous type with constant speed suitable for continuous duty operations. Stator is made of low watt loss steel laminations to deliver high efficiency. Dynamically balanced rotor and high quality bearings ensure vibration and noise free operations. The varnish impregnated windings are made of high-grade enameled copper wire.

Shaft is made of high quality steel, precision ground of ample size for transmitting the rated horsepower. Construction of motor frames and usage of quality materials result in high performance and low temperature rise, thereby increasing the life cycle of the motor. High-grade cast iron / Die-cast Aluminum components machined with close tolerance and high quality, heavy duty bearings are used to ensure better efficiency and longer life. All single and three phase motors require adequate control systems with necessary protections.

Motors are available with IE-3(Premium Efficiency) IE2(EFF-1), IE1(EFF-2) versions with B3, B14 & B5 mounting dimensions to cater various applications.

Applications : | Machine Tools | Blowers and Fans | Air-Conditioners | Compressors | Material Handling Equipments | Cranes and Hoist | Textile Machinery | Cement Plant | Pharmaceutical Machinery | Packaging Machinery | Construction Equipments | Agriculture | Food processing Machinery | Water treatment plants | General Engineering.



MATERIALS OF CONSTRUCTION

Motor Parts	Frame Size	Material
Stator frame	56 - 132	Aluminum alloy
	160 - 355	Cast iron
Endshield	56 - 90	Aluminum alloy
	100 - 355	Cast iron
Flanged endshield	56 - 132	Aluminum alloy
	160 - 355	Cast iron
Fan cover	71 - 355	Mild steel
Fan	71 - 355	Industrial nylon grade
Terminal box (1Ph)	71 - 90	Industrial nylon grade
Terminal box (3Ph)	71 - 132	Aluminum alloy
	160 - 355	Mild steel / Cast iron

PERMISSIBLE NO. OF COLD STARTS PER HOUR

The permissible number of starts per hour can be taken as given in the table below, provided the following conditions are met : Additional moment of inertia moment of inertia of the rotor: load torque rising with the square of the speed up to nominal torque ; starts at even intervals.

Frame size	Starts / Hours	Max. Starts / Day
56 - 71	100	250
80 - 100	60	140
112 - 132	30	60
160 - 180	15	30
200 - 225	8	15
250 - 355	4	8

TECHNICAL SPECIFICATIONS

Class of Motor	IE1	IE2	IE3
Type	Squirrel Cage Induction Motor	Squirrel Cage Induction Motor	Squirrel Cage Induction Motor
Power Range	0,37 - 2,2 kW, 1Ph, 230V, 50Hz 0,37 - 315 kW, 3Ph, 380-415V, 50Hz	0,75 - 315 kW 3Ph, 380-415V, 50Hz	0,75 - 315 kW 3Ph, 380-415V, 50Hz
Pole	2 Pole / 4 Pole (6 Pole on request)	2 Pole / 4 Pole (6 Pole on request)	2 Pole / 4 Pole (6 Pole on request)
Speed	2900 / 1450 rpm	2900 / 1450 rpm	2900 / 1450 rpm
Insulation Class	"F"	"F"	"F"
Protection	IP 44 / IP 55	IP 55	IP 55
Duty	Continuous (S1)	Continuous (S1)	Continuous (S1)
Ambient Temp.	40°C	40°C	40°C
Enclosure	TEFC	TEFC	TEFC
Mounting	Foot / Face / Flange	Foot / Face / Flange	Foot / Face / Flange
Direction of Rotation	Bi-Directional	Bi-Directional	Bi-Directional

EXPLODED VIEW

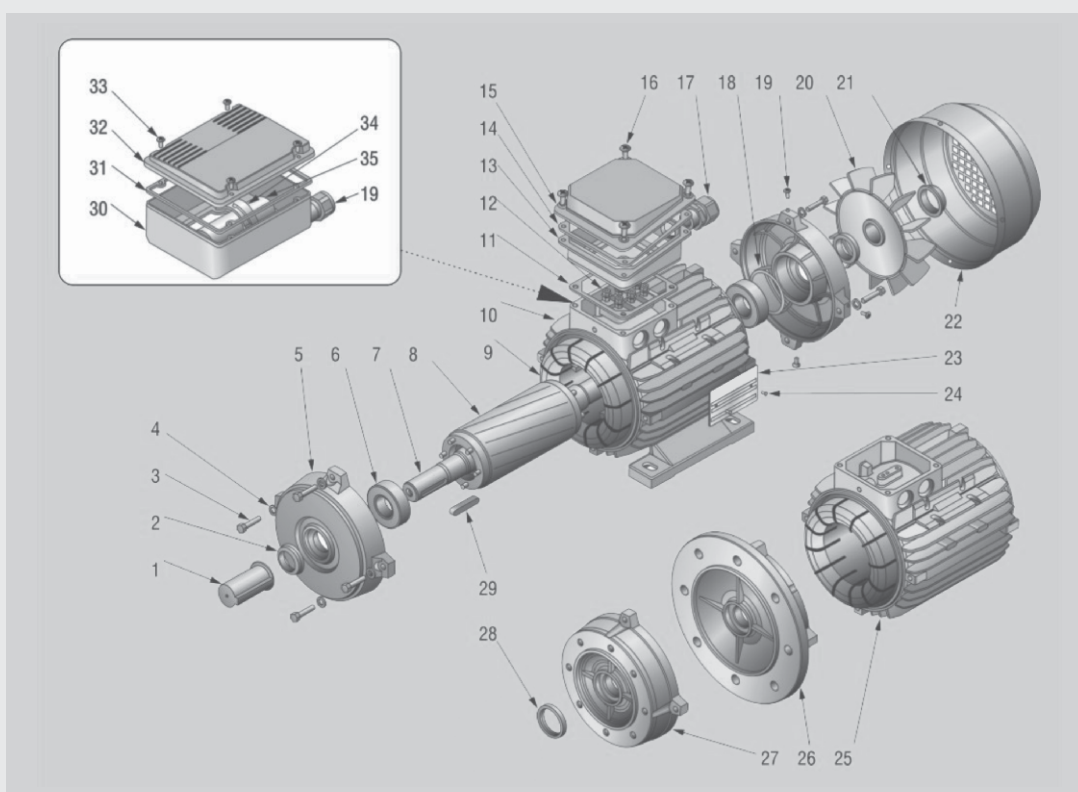

Part No.	Part Name	Part No.	Part Name	Part No.	Part Name	Part No.	Part Name
1	Shaft Cover	10	Motor Frame - B3	19	Screw Fan Cover	28	Dust Shield
2	Dust Shield	11	Gasket - Terminal Box	20	Cooling Fan	29	Shaft Key
3	Fixing Bolt - End shield	12	Terminal Block	21	Bush - Cooling Fan	30	Terminal Box - 1 Phase
4	Spring Washer	13	Terminal Box	22	Fan Cover	31	Gasket Terminal Box Cover (1Ph)
5	End shield	14	Gasket - Terminal Box Cover	23	Nameplate	32	Terminal Box Cover (1Ph)
6	Bearing	15	Terminal Box Cover	24	Nameplate Screw	33	Screw - Terminal Box (1Ph)
7	Motor Shaft	16	Screws - Terminal Box	25	Motor Frame - B5	34	Capacitor Clamp
8	Rotor	17	Cable Gland	26	Flange - B5	35	Capacitor
9	Wound Stator	18	Pre-load Washer	27	Flange - B14		

2 POLE, IE1 - MOTOR (230V SINGLE PHASE)

Model	Power		Speed (rpm)	Rated Current (A)	Efficiency (%)	Power Factor (CosØ)	Starting Current (A)	Starting Torque Ratio (T _A / T _N)	Tmax Ratio (T _M / T _N)	Weight (kg)
	kW	HP								
FI2BE-03M-71*	0,37	0,5	2800	2,73	67	0,92	16	1,8	1,8	8
FI2BE-05M-71*	0,55	0,75	2800	3,88	70	0,92	21	1,8	1,8	9
FI2BE-07S-80	0,75	1	2800	5,15	72	0,92	29	1,8	1,8	11
FI2BE-11S-80	1,1	1,5	2800	7,02	75	0,95	40	1,8	1,8	12
FI2BE-15S-90S	1,5	2	2800	9,44	76	0,95	55	1,7	1,8	15
FI2BE-22S-90L	2,2	3	2820	13,7	77	0,95	80	1,7	1,8	17

* PSC Type.

2 POLE, IE1 - MOTOR (380V THREE PHASE)

Model	Power		Speed (rpm)	Rated Current (A)	Efficiency (%)	Power Factor (CosØ)	Starting Current Ratio I _A / I _N	Starting Torque Ratio (T _A / T _N)	Tmax Ratio (T _M / T _N)	Weight (kg)
	kW	HP								
FI2BI-03T-71	0,37	0,5	2840	1,0	70	0,81	6,0	2,2	2,2	14
FI2BI-05T-71	0,55	0,75	2880	1,4	73	0,82	6,0	2,2	2,2	15
FI2BI-07T-80	0,75	1	2890	1,8	75	0,83	6,0	2,2	2,2	16
FI2BI-11T-80	1,1	1,5	2900	2,6	77	0,84	7,0	2,2	2,2	17
FI2BI-15T-90S	1,5	2	2900	3,4	79	0,84	7,0	2,2	2,2	22
FI2BI-22T-90L	2,2	3	2930	4,8	81	0,85	7,0	2,2	2,2	25
FI2BI-30T-100L	3	4	2930	6,3	83	0,87	7,0	2,2	2,2	34
FI2BI-40T-112M	4	5,5	2930	8,1	85	0,88	8,0	2,2	2,2	45
FI2BI-55T-132S	5,5	7,5	2940	11	86	0,88	8,0	2,2	2,2	67
FI2BI-75T-132S	7,5	10	2950	15	87	0,88	8,0	2,2	2,2	71
FI2BI-110T-160M	11	15	2950	21,3	88	0,88	8,0	2,0	2,2	107
FI2BI-150T-160M	15	20	2970	28,7	89	0,89	8,0	2,0	2,2	107
FI2BI-185T-160L	18,5	25	2970	34,6	90	0,9	8,0	2,0	2,2	134
FI2BI-220T-180M	22	30	2970	40,9	90,5	0,9	8,0	2,0	2,2	169
FI2BI-300T-200L	30	40	2970	55,4	91,2	0,9	8,0	2,0	2,2	220
FI2BI-370T-200L	37	50	2980	67,7	92	0,9	8,0	2,0	2,2	239
FI2BI-450T-225M	45	60	2980	82,3	92,3	0,9	8,0	1,8	2,2	297
FI2BI-550T-250M	55	75	2980	101	92,5	0,9	7,0	1,8	2,2	377
FI2BI-750T-280S	75	100	2980	134	93	0,9	7,0	1,8	2,2	510
FI2BI-900T-280M	90	125	2980	160	93,8	0,91	7,0	1,8	2,2	577
FI2BI-A10T-315S	110	150	2980	195	94	0,91	6,8	1,8	2,2	920
FI2BI-A32-315M	132	180	2980	233	94,5	0,91	6,8	1,8	2,2	970
FI2BI-A60-315L	160	215	2980	279	94,6	0,92	6,8	1,8	2,2	1080
FI2BI-B00-315L	200	270	2980	348	94,8	0,92	6,8	1,8	2,2	1130
FI2BI-B50-355M	250	335	2980	433	94,8	0,92	7,0	1,6	2,2	1850
FI2BI-C15-355L	315	420	2980	544	94,8	0,92	7,0	1,6	2,2	1900

4 POLE, IE1 MOTOR (SINGLE PHASE)

Model	Power		Speed	Rated Current (A)	Efficiency $\eta\%$	Power Factor $\cos\phi$	Starting Current (A)	Starting Torque Ratio (T_A / T_N)	Tmax Ratio (T_M / T_N)	Weight (kg)
	kW	HP								
FI4BE-03M-71*	0,37	0,5	1400	2,81	65	0,92	16	1,8	1,8	9
FI4BE-05M-71*	0,55	0,75	1400	4,0	68	0,92	21	1,8	1,8	11
FI4BE-07S-80	0,75	1	1400	5,22	71	0,92	30	1,8	1,8	12
FI4BE-11S-90S	1,1	1,5	1400	7,2	73	0,95	40	1,7	1,8	13
FI4BE-15S-90L	1,5	2	1400	9,57	75	0,95	55	1,7	1,8	17
FI4BE-22S-100L	2,2	3	1400	13,9	76	0,95	80	1,7	1,8	26
FI4BE-30S-100L	3	4	1400	18,6	77	0,95	110	1,7	1,8	28

* PSC Type.

4 POLE, IE1 MOTOR (THREE PHASE)

Model	Power		Speed (rpm)	Rated Current (A)	Efficiency (%)	Power Factor (Cos ϕ)	Starting Current Ratio I_A / I_N	Starting Torque Ratio (T_A / T_N)	Tmax Ratio (T_M / T_N)	Weight (kg)
	kW	HP								
FI4BI-03T-71	0,37	0,5	1400	1,12	67	0,75	5,5	2,2	2,2	16
FI4BI-05T-80	0,55	0,75	1400	1,6	71	0,75	5,5	2,2	2,2	17
FI4BI-07T-80	0,75	1	1400	2,0	73	0,77	6,0	2,2	2,2	18
FI4BI-11T-90S	1,1	1,5	1400	2,9	75	0,77	6,0	2,2	2,2	23
FI4BI-15T-90L	1,5	2	1400	3,7	78	0,79	6,0	2,2	2,2	27
FI4BI-22T-100L	2,2	3	1420	5,1	80	0,81	7,0	2,2	2,2	35
FI4BI-30T-100L	3	4	1420	6,8	82	0,82	7,0	2,2	2,2	38
FI4BI-40T-112M	4	5,5	1440	8,8	84	0,82	7,0	2,2	2,2	49
FI4BI-55T-132S	5,5	7,5	1440	11,8	85	0,83	7,0	2,2	2,2	67
FI4BI-75T-132M	7,5	10	1440	15,5	87	0,84	7,0	2,0	2,0	80
FI4BI-110T-160M	11	15	1460	22,3	88	0,85	7,0	2,0	2,2	124
FI4BI-150T-160L	15	20	1460	30,1	89	0,85	7,0	2,0	2,2	147
FI4BI-185T-180M	18,5	25	1470	36,4	90,5	0,85	7,5	2,2	2,2	169
FI4BI-220T-180L	22	30	1470	43,1	91	0,85	7,5	2,2	2,2	184
FI4BI-300T-200L	30	40	1470	57,4	92	0,86	7,5	2,2	2,2	241
FI4BI-370T-225S	37	50	1480	69,9	92,5	0,87	7,5	2,2	2,2	300
FI4BI-450T-225M	45	60	1480	84,7	92,8	0,87	7,5	2,2	2,2	322
FI4BI-550T-250M	55	75	1480	103	93	0,89	7,0	2,2	2,2	400
FI4BI-750T-280S	75	100	1480	140	93,8	0,86	7,0	2,2	2,2	546
FI4BI-900T-280M	90	125	1490	167	94	0,86	7,0	2,2	2,2	620
FI4BI-A10T-315S	110	150	1490	201	94,2	0,87	6,9	2,1	2,2	921
FI4BI-A32T-315M	132	180	1490	240	94,5	0,87	6,9	2,1	2,2	1002
FI4BI-A60T-315L	160	215	1490	287	94,8	0,88	6,9	2,1	2,2	1070
FI4BI-B00T-315L	200	270	1490	359	94,9	0,88	6,9	2,3	2,2	1170
FI4BI-B50T-355M	250	335	1485	443	94,9	0,88	6,9	2,3	2,2	1580
FI4BI-C15T-355L	315	420	1485	556	94,9	0,89	6,9	2,2	2,2	1700

2 POLE, IE2 MOTOR (380-415V THREE PHASE)

Model	Power		Speed (rpm)	Rated Current (A)			Efficiency (%)	Power Factor (CosØ)	Starting Current Ratio I_A / I_N	Starting Torque Ratio (T_A / T_N)	Tmax Ratio (T_M / T_N)	Rated Torque Nm	Weight (kg)
	kW	HP		380	400	415							
FI2BI-07T-80-2	0,75	1	2875	1,77	1,69	1,62	77,4	0,83	5,30	2,5	3	2,49	16
FI2BI-11T-80-2	1,1	1,5	2875	2,53	2,4	2,32	79,6	0,83	7,00	3,2	3,8	3,65	17
FI2BI-15T-90S-2	1,5	2	2890	3,34	3,17	3,06	81,3	0,84	7,10	2,7	3,5	4,96	22,5
FI2BI-22T-90L-2	2,2	3	2890	4,73	4,49	4,32	83,2	0,85	6,90	2,4	3	7,27	25
FI2BI-30T-100L-2	3	4	2891	6,19	5,88	5,67	84,6	0,87	8,00	3,2	4	9,91	34,5
FI2BI-40T-112M-2	4	5,5	2914	8,05	7,65	7,37	85,8	0,88	7,50	2,5	3	13,11	45
FI2BI-55T-132S-2	5,5	7,5	2937	10,9	10,4	10,0	87,0	0,88	7,50	2,7	3,5	17,88	72
FI2BI-75T-132S-2	7,5	10	2940	14,5	13,8	13,3	88,1	0,89	7,50	2,4	3,3	24,36	80
FI2BI-110T-160M-2	11	15	2930	21,0	20	19,2	89,4	0,89	7,60	2,2	2,9	35,85	108
FI2BI-150T-160M-2	15	20	2930	28,4	26,9	26,0	90,3	0,89	7,60	2,3	3	48,89	117
FI2BI-185T-160L-2	18,5	25	2937	34,7	33	31,8	90,9	0,89	7,40	2,3	3,1	60,15	135
FI2BI-220T-180M-2	22	30	2940	41,1	39,1	37,7	91,3	0,89	7,80	2,8	3,2	71,46	183
FI2BI-300T-200L-2	30	40	2950	55,7	52,9	51,0	92,0	0,89	7,80	2,6	3	97,12	227
FI2BI-370T-200L-2	37	50	2950	68,3	64,9	62,5	92,5	0,89	7,70	2,6	3	119,78	247
FI2BI-450T-225M-2	45	60	2960	82,7	78,6	75,7	92,9	0,89	7,50	2,4	2,6	145,19	297
FI2BI-550T-250M-2	55	75	2965	100,7	95,7	92,2	93,2	0,89	7,10	2,3	2,8	177,15	390
FI2BI-750T-280S-2	75	100	2970	136,5	129,7	125	93,8	0,89	7,40	2,5	2,8	241,16	519
FI2BI-900T-280M-2	90	125	2970	163,3	155,1	149,5	94,1	0,89	7,60	2,8	2,8	289,39	588
FI2BI-A10T-315S-2	110	150	2975	196,9	187,1	180,3	94,3	0,90	6,9	2,4	2,8	353,11	948
FI2BI-A32T-315M-2	132	180	2975	235,6	223,8	215,7	94,6	0,90	7,1	2,6	2,9	423,73	1009
FI2BI-A60T-315L-2	160	215	2975	281,8	267,7	258	94,8	0,91	7,1	2,5	2,9	513,61	1111
FI2BI-B00T-315L-2	200	270	2975	351,5	333,9	321,9	95	0,91	6,9	2,5	2,8	642,02	1140
FI2BI-B50T-355M-2	250	335	2980	439,4	417,4	402,3	95	0,91	7,0	2,5	2,8	801,17	1938
FI2BI-C15T-355L-2	315	420	2980	553,6	525,9	506,9	95	0,91	7,0	2,5	2,9	1009,48	2342

4 POLE, IE2 MOTOR (380-415V THREE PHASE)

Model	Power		Speed (rpm)	Rated Current (A)			Efficiency (%)	Power Factor (CosØ)	Starting Current Ratio I_A / I_N	Starting Torque Ratio (T_A / T_N)	Tmax Ratio (T_M / T_N)	Rated Torque Nm	Weight (kg)
	kW	HP		380	400	415							
FI4BI-07T-80-2	0,75	1	1400	1,91	1,81	1,75	79,6	0,75	5	2,4	2,9	5,12	18
FI4BI-11T-90S-2	1,1	1,5	1440	2,74	2,6	2,51	81,4	0,75	6	3	3,5	7,3	22
FI4BI-15T-90L-2	1,5	2	1445	3,67	3,49	3,36	82,8	0,75	6,8	3,2	3,8	9,91	27
FI4BI-22T-100L-2	2,2	3	1440	4,9	4,65	4,48	84,3	0,81	7	3	3,5	14,6	35
FI4BI-30T-100L-2	3	4	1140	6,5	6,18	5,95	85,5	0,82	7	2,6	3,3	19,9	41,5
FI4BI-40T-112M-2	4	5,5	1445	8,56	8,13	7,84	86,6	0,82	7,5	3,5	4	26,4	49
FI4BI-55T-132S-2	5,5	7,5	1455	11,6	11	10,6	87,7	0,82	6,4	2,2	2,8	36,1	77
FI4BI-75T-132M-2	7,5	10	1455	15,5	14,7	14,2	88,7	0,83	7	2,4	3	49,2	87
FI4BI-110T-160M-2	11	15	1460	21,9	20,8	20	89,8	0,85	6,9	2,5	2,9	71,9	110
FI4BI-150T-160L-2	15	20	1460	29,2	27,8	26,8	90,6	0,86	7,5	2,5	3	98,1	132
FI4BI-185T-180M-2	18,5	25	1470	35,8	34	32,8	91,2	0,86	7,8	2,6	3,1	120,2	172
FI4BI-220T-180L-2	22	30	1470	42,4	40,3	38,9	91,6	0,86	7,5	2,6	3,1	142,9	180
FI4BI-300T-200L-2	30	40	1470	57,4	54,6	52,6	92,3	0,86	7,1	2,4	2,9	194,9	247
FI4BI-370T-225S-2	37	50	1480	70,5	67	64,6	92,7	0,86	7,5	2,5	2,7	238,8	297
FI4BI-450T-225M-2	45	60	1480	85,4	81,1	78,2	93,1	0,86	7,6	2,5	2,8	290,4	322
FI4BI-550T-250M-2	55	75	1480	103,9	98,7	95,2	93,5	0,86	7,3	2,6	2,7	354,9	413
FI4BI-750T-280S-2	75	100	1480	137,8	130,9	126,1	94,0	0,88	7,6	2,7	2,7	484	558
FI4BI-900T-280M-2	90	125	1480	155	156,7	151	94,2	0,88	7,5	2,7	2,7	580,7	632
FI4BI-A10T-315S-2	110	150	1485	201	190,9	184	94,5	0,88	7,1	2,7	2,9	707,4	950
FI4BI-A32T-315M-2	132	180	1485	240,7	228,6	220,4	94,7	0,88	7,3	2,7	2,9	889	1035
FI4BI-A60T-315L-2	160	215	1485	287,8	273,4	263,5	94,9	0,89	7,4	3	3,0	1029	1105
FI4BI-B00T-315L-2	200	270	1485	359	341,1	328,7	95,1	0,89	7,6	3	3,0	1286	1225
FI4BI-B50T-355M-2	250	335	1490	443,8	421,6	406,4	95,1	0,90	7,5	2,8	2,9	1602	1740
FI4BI-C15T-355L-2	315	420	1490	559	531,2	512	95,1	0,90	7,4	2,6	2,8	2019	1900

2 POLE, IE3 MOTOR (380-415V THREE PHASE)

Model	Power		Speed (rpm)	Rated Current (A)			Efficiency (%)	Power Factor (CosØ)	Starting Current Ratio I_A / I_N	Starting Torque Ratio (T_A / T_N)	Tmax Ratio (T_M / T_N)	Rated Torque Nm	Weight (kg)
	kW	HP		380	400	415							
FI2BI-07T-80-3	0,75	1	2880	1,7	1,61	1,56	80,7	0,83	5,5	1,8	3,5	2,49	20
FI2BI-11T-80-3	1,1	1,5	2880	2,43	2,31	2,22	82,7	0,83	7,5	2,6	3,5	3,65	21
FI2BI-15T-90S-3	1,5	2	2895	3,25	3,09	2,98	84,2	0,83	7,1	2,6	3,5	4,95	26
FI2BI-22T-90L-3	2,2	3	2895	4,57	4,34	4,19	85,9	0,85	7	2	3	7,26	29
FI2BI-30T-100L-3	3	4	2895	5,94	5,64	5,44	87,1	0,88	8,6	2	3,2	9,9	43
FI2BI-40T-112M-3	4	5,5	2905	7,83	7,44	7,17	88,1	0,88	8	1,8	2,9	13,1	51
FI2BI-55T-132S-3	5,5	7,5	2930	10,6	10,1	9,75	89,2	0,88	7,5	2,1	2,5	17,9	76
FI2BI-75T-132S-3	7,5	10	2930	14,4	13,7	13,2	90,1	0,88	7,3	2	3,5	24,4	84
FI2BI-110T-160M-3	11	15	2945	20,4	19,3	18,6	91,2	0,90	7,3	2,3	2,6	35,7	128
FI2BI-150T-160M-3	15	20	2945	27,2	25,9	24,9	91,9	0,91	7	1,9	2,3	48,6	140
FI2BI-185T-160L-3	18,5	25	2940	34,1	32,4	31,3	92,4	0,89	7	1,6	2,5	60,1	155
FI2BI-220T-180M-3	22	30	2955	40,1	38,1	36,7	92,7	0,90	7	1,6	2,5	71,1	192
FI2BI-300T-200L-3	30	40	2960	54,8	52,1	50,2	93,3	0,89	7	1,5	2,5	96,8	246
FI2BI-370T-200L-3	37	50	2960	65,9	62,6	60,3	93,7	0,91	7,3	1,5	2,5	119	267
FI2BI-450T-225M-3	45	60	2965	82,5	78,4	75,5	94,0	0,88	6,8	1,6	2,5	145	353
FI2BI-550T-250M-3	55	75	2970	99,6	94,6	91,2	94,3	0,89	7,2	1,6	2,6	176,9	408
FI2BI-750T-280S-3	75	100	2975	134	127	122	94,7	0,91	7,2	1,2	2	240,8	548
FI2BI-900T-280M-3	90	125	2975	162	153	148	95,0	0,89	7,4	1,2	2	288,9	596
FI2BI-A10T-315S-3	110	150	2978	195	185	179	95,2	0,90	7,3	1,2	2	352,8	956
FI2BI-A32T-315M-3	132	175	2978	233	222	214	95,4	0,90	7,3	1,3	2,1	432,3	1017
FI2BI-A60T-315L-3	160	215	2980	283	268	259	95,6	0,90	6,8	1,2	2	512,8	1119
FI2BI-B00T-315L-3	200	270	2980	349	331	319	95,8	0,91	7,8	1,1	2	640,9	1150
FI2BI-B50T-355M-3	250	335	2982	431	409	394	95,8	0,92	7,9	1,1	2	800,6	1948
FI2BI-C15T-355L-3	315	425	2982	543	519	497	95,8	0,92	7,9	1,1	2	1009	2356

4 POLE, IE3 MOTOR (380-415V THREE PHASE)

Model	Power		Speed (rpm)	Rated Current (A)			Efficiency (%)	Power Factor (CosØ)	Starting Current Ratio I_A / I_N	Starting Torque Ratio (T_A / T_N)	Tmax Ratio (T_M / T_N)	Rated Torque Nm	Weight (kg)
	kW	HP		380	400	415							
FI4BI-07T-80-3	0,75	1	1420	1,86	1,77	1,7	82,5	0,74	6	2,9	3,6	5,04	22
FI4BI-11T-90S-3	1,1	1,5	1445	2,68	2,55	2,46	84,1	0,74	6,5	2,7	3,8	7,27	27
FI4BI-15T-90L-3	1,5	2	1445	3,61	3,43	3,3	85,3	0,74	6,8	3	3,6	9,91	32
FI4BI-22T-100L-3	2,2	3	1435	4,93	4,68	4,52	86,7	0,78	7,2	2,5	3,5	14,6	44
FI4BI-30T-100L-3	3	4	1435	6,66	6,32	6,09	87,7	0,78	7,2	2,6	3,5	20	49
FI4BI-40T-112M-3	4	5,5	1440	8,56	8,14	7,84	88,6	0,80	7	2,3	3,2	26,5	56
FI4BI-55T-132S-3	5,5	7,5	1460	11,6	11,1	10,7	89,6	0,80	7,1	2,7	3,5	36	81
FI4BI-75T-132M-3	7,5	10	1460	15,3	14,6	14	90,4	0,82	7,2	2,7	3,8	49,1	91
FI4BI-110T-160M-3	11	15	1465	22,3	21,2	20,4	91,4	0,82	6,8	1,9	2,3	71,7	141
FI4BI-150T-160L-3	15	20	1465	30,1	28,6	27,6	92,1	0,82	6,8	1,8	2,4	97,8	151
FI4BI-185T-180M-3	18,5	25	1470	36,1	34,3	33,1	92,6	0,84	6,9	1,8	2,5	120,2	190
FI4BI-220T-180L-3	22	30	1470	42,3	40,2	38,7	93,0	0,85	7	1,8	2,5	142,9	205
FI4BI-300T-200L-3	30	40	1475	56,5	53,7	51,7	93,6	0,86	6,8	1,8	2,3	194,2	275
FI4BI-370T-225S-3	37	50	1485	69,5	66,1	63,7	93,9	0,86	7,1	1,7	2,3	237,9	315
FI4BI-450T-225M-3	45	60	1485	83,2	79,1	76,2	94,2	0,87	7,1	1,8	2,4	289,4	345
FI4BI-550T-250M-3	55	75	1485	101	96,2	92,7	94,6	0,87	7	1,8	2,4	353,7	421
FI4BI-750T-280S-3	75	100	1486	138	131	126	95,0	0,87	6,9	1,8	2,2	482	538
FI4BI-900T-280M-3	90	125	1486	165	157	151	95,2	0,87	7,2	1,6	2,1	578,4	638
FI4BI-A10T-315S-3	110	150	1488	199	189	182	95,4	0,88	7,2	1,6	2,1	706	958
FI4BI-A32T-315M-3	132	175	1488	238	226	218	95,6	0,88	7,2	1,5	2,0	847	1045
FI4BI-A60T-315L-3	160	215	1488	288	274	264	95,8	0,88	6,8	1,5	2,0	1027	1115
FI4BI-B00T-315L-3	200	270	1490	360	342	329	96	0,88	7,2	1,6	2,1	1282	1233
FI4BI-B50T-355M-3	250	335	1490	449	427	411	96	0,88	7,3	1,4	2,1	1603	1744
FI4BI-C15T-355L-3	315	425	1490	567	538	519	96	0,88	7,4	1,4	2,0	2019	1950

DIMENSIONAL DETAILS

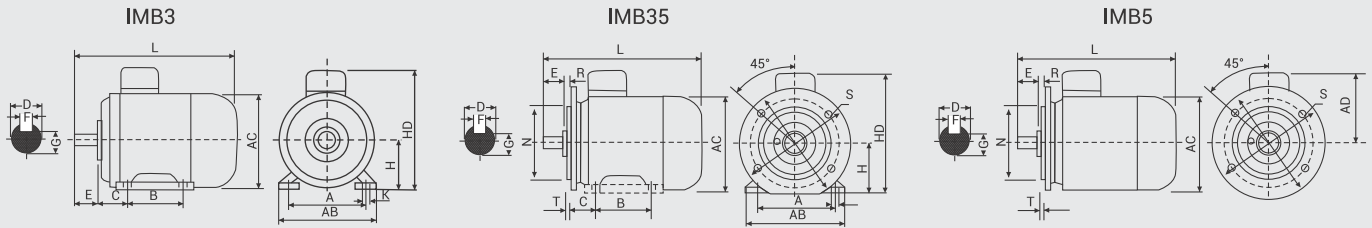

Frame Size	Mounting Dimensions (mm)																	Frame Dimensions (mm)							
	A	B	C	D		E		F		G		H	K	M	N	P	R	S	T	AB	AC	AD	HD	L	
				2 Pole	4 Pole	2 Pole	4 Pole	2 Pole	4 Pole	2 Pole	4 Pole													2 Pole	4 Pole
71	112	90	45	14	14	30	30	5	5	11	11	71	7	130	110	160	0	10	3	150	145	80	195	255	255
80	125	100	50	19	19	40	40	6	6	15,5	15,5	80	10	165	130	200	0	12	3,5	165	175	145	220	295	295
90S	140	100	56	24	24	50	50	8	8	20	20	90	10	165	130	200	0	12	3,5	180	195	155	250	320	320
90L	140	125	56	24	24	50	50	8	8	20	20	90	10	165	130	200	0	12	3,5	180	195	155	250	345	345
100L	160	140	63	28	28	60	60	8	8	24	24	100	12	215	180	250	0	15	4	205	215	180	270	385	385
112M	190	140	70	28	28	60	60	8	8	24	24	112	12	215	180	250	0	15	4	230	240	190	300	400	400
132S	216	140	89	38	38	80	80	10	10	33	33	132	12	265	230	300	0	15	4	270	275	210	345	470	470
132M	216	178	89	38	38	80	80	10	10	33	33	132	12	265	230	300	0	15	4	270	275	210	345	510	510
160M	254	210	108	42	42	110	110	12	12	37	37	160	15	300	250	350	0	19	5	315	330	255	400	605	605
160L	254	254	108	42	42	110	110	12	12	37	37	160	15	300	250	350	0	19	5	315	330	255	400	660	660
180M	279	241	121	48	48	110	110	14	14	42,5	42,5	180	15	300	250	350	0	19	5	355	380	280	440	690	690
180L	279	279	121	48	48	110	110	14	14	42,5	42,5	180	15	300	250	350	0	19	5	355	380	280	440	725	725
200L	318	305	133	55	55	110	110	16	16	49	49	200	19	350	300	400	0	19	5	410	420	305	500	765	765
225S	356	286	149	-	60	-	140	-	18	-	53	225	19	400	350	450	0	19	5	445	470	335	555	-	810
225M	356	311	149	55	60	110	140	16	18	49	53	225	19	400	350	450	0	19	5	445	470	335	550	805	835
250M	406	349	168	60	65	140	140	18	18	53	58	250	24	500	450	550	0	19	5	485	510	370	615	910	910
280S	457	368	190	65	75	140	140	18	20	58	67,5	280	24	500	450	550	0	19	5	550	580	410	660	980	980
280M	457	419	190	65	75	140	140	18	20	58	67,5	280	24	500	450	550	0	19	5	550	580	410	660	1030	1030
315S	508	406	216	65	80	140	170	18	22	58	71	315	28	600	550	660	0	24	6	630	645	630	825	1180	1275
315M	508	457	216	65	80	140	170	18	22	58	71	315	28	600	550	660	0	24	6	630	645	630	830	1290	1320
315L	508	508	216	65	80	140	170	18	22	58	71	315	28	600	550	660	0	24	6	630	645	630	830	1290	1320
355M	610	560	254	75	95	140	170	20	25	67,5	86	355	28	740	680	800	0	24	6	705	710	655	1010	1510	1540
355L	610	630	254	75	95	140	170	20	25	67,5	86	355	28	740	680	800	0	24	6	705	710	655	1010	1510	1540

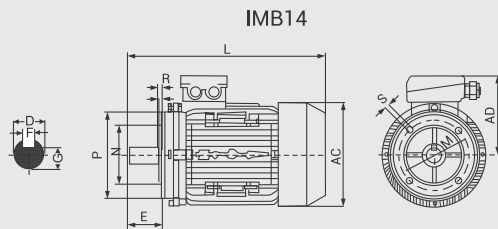

Frame Size	Mounting Dimensions (mm)										Frame Dimensions (mm)		
	E	F	D	G	M	N	P	R	S	AC	AD	L	
71	30	5	14	11	85	70	105	0	M6	150	110	246	
80	40	6	19	15,5	100	80	120	0	M6	170	135	285	
90S	50	8	24	20	115	95	140	0	M8	185	137	335	
90L	50	8	24	20	115	95	140	0	M8	185	137	335	
100L	60	8	28	24	130	110	160	0	M8	206	150	376	
112M	80	8	28	24	130	110	160	0	M8	228	170	400	
132S	80	10	38	33	165	130	200	0	M10	267	190	460	
132M	110	10	38	33	165	130	200	0	M10	267	190	500	
160M	110	12	42	37	215	180	250	0	M12	330	255	615	
160L	110	12	42	37	215	180	250	0	M12	330	255	675	
180M	110	14	48	42,5	265	230	300	0	M15	380	280	700	
180L	110	14	48	42,5	265	230	300	0	M15	380	280	740	

SHAFT & KEY DIMENSIONS

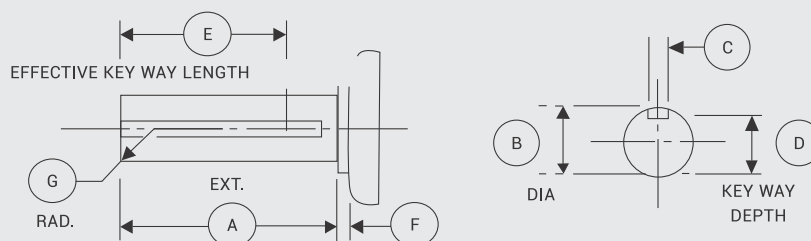

Frame	A		B		C		D		E		F		G	
	2 Pole	4 Pole	2 Pole	4 Pole	2 Pole	4 Pole	2 Pole	4 Pole	2 Pole	4 Pole	2 Pole	4 Pole	2 Pole	4 Pole
D.71	30	-	14	-	5 x 5	-	11	-	14	-	-	-	-	-
D.80	40	-	19	-	6 x 6	-	15,5	-	25	-	-	-	-	-
D.90	50	-	24	-	8 x 7	-	20	-	32	-	-	-	-	-
D.100	60	-	28	-	8 x 7	-	23,9	-	40	-	-	-	-	-
D.112	60	-	28	-	8 x 7	-	23,9	-	40	-	-	-	-	-
D.132	80	-	38	-	10 x 8	-	33	-	56	-	-	-	-	-
D.160	110	-	42	-	12 x 8	-	37	-	80	-	-	-	-	-
D.180	110	-	48	-	14 x 9	-	42,5	-	80	-	-	-	-	-
D.200	110	-	55	-	16 x 10	-	48,8	-	80	-	-	-	-	-
D.225	110	140	55	60	16 x 10	18 x 11	48,8	53	80	110	110	110	110	110
D.250	140	140	60	70	18 x 11	20 x 12	53	62,5	110	110	110	110	110	110
D.280	140	170	65	80	18 x 11	20 x 12	58	71	110	140	140	140	140	140
D.315S-M	140	170	65	85	18 x 11	22 x 14	58	76	110	140	140	140	140	140
D.315L		170		90		25 x 14		81		140	140	140	140	140





DEGREE OF PROTECTION

Degrees of protection for mechanical machines are designated in accordance with IS 4691 / IEC 60034-5 by the letters IP and two characteristic numerals.

First numeral : Protection against contact and ingress of foreign bodies ↓	No. special protection	Protection against vertically falling water drops	Protection against dripping water when inclined by up to 15 degrees	Protection against water spray when inclined by up to 60 degrees from vertical	Protection against water splashed from any direction	Protection against water projected by nozzle from any direction	Protection against Powerful jet		
Second Numeral : Protection against ingress of water →	0	1	2	3	4	5	6		
0	No special protection								
1	Protection against solid foreign objects > 50 mm (Example: inadvertent contact with hand)								
2	Protection against solid foreign objects > 12 mm (Example: inadvertent contact with the fingers)		IP 21	IP 22	IP 23				
3	Protection against solid foreign objects > 2,5 mm (Example: Inadvertent contact with wire & tools)								
4	Protection against solid foreign objects > 1 mm (Example: Inadvertent contact with wire, bands)					IP 44			
5	Protection against dust (Harmful deposits of dust)					IP 54	IP 55	IP 56	

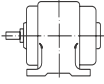
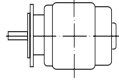
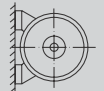
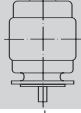
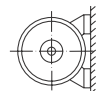
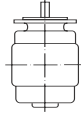
MOUNTING ARRANGEMENTS

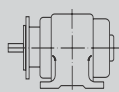
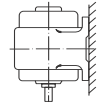
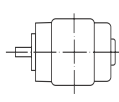
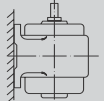
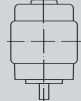
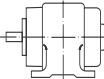
Mounting arrangements for rotating electrical machines are designated according to IS 2253 / IEC 60034-7. Our motors are available with the mounting arrangements listed below, depending on design and frame size.

Foot mounting	Flange mounting
 <p>B3 - Horizontal foot mounted</p>	 <p>B5 - Flange type 'D'</p>
 <p>B6 - Horizontal wall mounted (LHS)</p>	 <p>V1 - Vertical down wards flange type 'D'</p>
 <p>B7 - Horizontal wall mounted (RHS)</p>	 <p>V3 - Vertical up wards flange type 'D'</p>
 <p>B8 - Horizontal ceiling mounted</p>	 <p>B35 - Horizontal base flange type 'D'</p>
 <p>V5 - Wall mounted shaft down wards</p>	 <p>B14 - Horizontal face flange type 'C'</p>
 <p>V6 - Wall mounted shaft up wards</p>	 <p>V18 - Vertical face down wards flange type 'C'</p>
 <p>B34 - Horizontal base flange type 'C'</p>	 <p>V19 - Vertical face up wards flange type 'C'</p>

It is essential to state the desired mounting arrangement when ordering, as the constructive design depends partly on the mounting arrangement.

ELECTRICAL PARAMETERS

RATED VOLTAGE

Motors are suitable for variation of $\pm 10\%$ of the rated voltage. Therefore the motors are designed for the following rated voltage ranges

- Rated voltage
- 230 V $\pm 10\%$
- 415 V $\pm 10\%$
- 690 V $\pm 10\%$

RATED CURRENT OR FULL LOAD CURRENT

As the torque load on a motor increases, the amperage required to power the motor also increases. When the full-load torque and horsepower is reached, the corresponding amperage is known as the full-load amperage (FLA).

STARTING CURRENT

It is usually given as a percentage or as a multiple of rated current. The starting current is the value of the current drawn by the motor during starting. The value of the starting current is generally between 5 to 7 times of the rated current.

RATED POWER

Rated power is the measure of how much work a motor can be expected to do. This value is based on the motor's full-load torque and full-load speed ratings and is calculated as follows:

$$\text{Horsepower (hp)} = [\text{Motor Speed} \times \text{Torque (lb-ft)}] \div 5,250$$

ELECTRICAL PARAMETERS

INPUT POWER (kW)

The Amount of power the motor consumes to produce the output power.

OUTPUT POWER (kW)

The Amount of power motor can produce at shaft and not reduce life of motor.

RATED FREQUENCY

Motors are suitable for 50Hz with a variation of $\pm 5\%$

NUMBER OF POLES

Number of poles of the motor determine the basic speed of the motor. Standard motors are available in the configuration of 2, 4, 6 and 8 poles

RATED SPEED

Speed of the motor runs at when fully loaded and supplied rated nameplate voltage.

$$\text{Speed (n)} = \frac{120f}{P}$$

n = Speed in rpm
f = Frequency in hertz
P = No. of Poles

SLIP

The rotor in an induction motor lags slightly behind the synchronous speed of the changing polarity of the magnetic field. Due to this, the actual speed of an induction motor is always somewhat less than its synchronous speed. The difference between the synchronous and actual speed is called slip.

Induction motors are made with slip ranging from less than 5% up to 20%. A motor with a slip of 5% or less is known as a normal-slip motor.

Slip is expressed as

$$S = \left(\frac{n_s - n_a}{n_s} \right) \times 100\%$$

where

S = slip in %

n_s = synchronous speed (rpm)

n_a = Actual speed (rpm)

SERVICE FACTOR

Service factor (SF) is an indication of how much overload a motor can withstand when operating normally within the correct voltage tolerances.

POWER FACTOR

Power factor is the ratio of motor load watts divided by volt-amps at the full-load condition. Power factor for a motor changes with its load. Power factor is minimum at no load and increases as additional load is applied to the motor. Power factor usually reaches a peak at or near full load on the motor.

TORQUE

Torque is the turning effort. Torque is the turning force through a radius with the units – Nm in the SI-system and lbft in the imperial system. The torque developed by an induction motor varies when the motor accelerates from full stop or zero speed to maximum operating speed.

STARTING TORQUE

Starting Torque is the torque the electrical motor develop when its starts at rest or zero speed.

ELECTRICAL PARAMETERS

FULL-LOAD (RATED) TORQUE OR BRAKING TORQUE

The Full-load Torque is the torque required to produce the rated power of the electrical motor at full-load speed.

In imperial units the Full-load Torque can be expressed as

$$T = 5252 P_{hp} / n_r$$

where

T = full-load torque (lbft)

P_{hp} = rated horsepower

n_r = rated rotational speed (rpm)

In metric units the rated torque can be expressed as

$$T = 9550 P_{kW} / n_r$$

where

T = rated torque (Nm)

P_{kW} = rated power (kW)

n_r = rated rotational speed (rpm)

FULL-LOAD EFFICIENCY

The efficiency is given as a percentage and indicates how well the motor converts electrical power into mechanical power. The closer this value is to 100%, the lower the electricity consumption cost is going to be. Generally, larger motors will be more efficient than smaller motors.

The efficiency value that appears on the nameplate is the nominal full-load efficiency

INSULATION CLASS AND RATED AMBIENT TEMPERATURE

A critical element in motor life is the maximum temperature that occurs at the hottest spot in the motor. The temperature that occurs at that spot is a combination of motor design (temperature rise) and the ambient (surrounding) temperature.

MOMENT OF INERTIA

The moment of inertia of an induction motor is used to calculate the required starting torque of the motor and to ensure that it is capable of accelerating the rotating mass up to synchronous speed without stalling. Moment of inertia is time taken by an induction motor to reach at rated speed & rated torque at rated voltage without stalling.

CONNECTION TYPES

Windings of standard three phase motors can be connected either in star or delta connection

STAR CONNECTION

In STAR connection, the starting or finishing ends (Similar ends) of three coils are connected together to form the neutral point. A common wire is taken out from the neutral point which is called Neutral.

Line Current is Equal to Phase Current. i.e. Line Current = Phase Current

$$I_L = I_{PH}$$

Line Voltage is $\sqrt{3}$ times of Phase Voltage. i.e.

$$V_L = \sqrt{3} V_{PH}$$

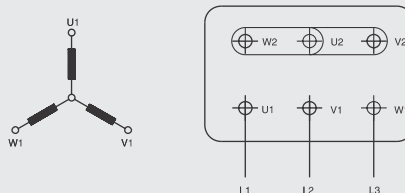

DELTA CONNECTION

In DELTA connection, the opposite ends of three coils are connected together. In other words, the end of each coil is connected with the start of another coil, and three wires are taken out from the coil joints

Line Voltage is Equal to Phase Voltage. i.e. Line Voltage = Phase Voltage

$$V_L = V_{PH}$$

Line Current is $\sqrt{3}$ times of Phase Current. i.e.

$$I_L = \sqrt{3} I_{PH}$$

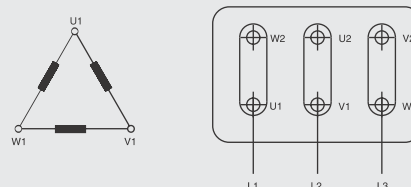

ELECTRICAL PARAMETERS

STARTING METHODS FOR AC MOTORS

Reducing Electrical and Mechanical Stress at Start-up

The starting current of an AC motor can vary from 3 to 7 times the full load current. This is because a large amount of energy is required to magnetise the motor enough to overcome the inertia the system has at standstill. The high current drawn from the network can cause problems such as voltage drop, high transients and in some cases, uncontrolled shutdown. High starting current also causes great mechanical stress on the motor's rotor bars and windings and can affect the driven equipment and the foundations. Several starting methods exist, all aiming to reduce these stresses. The load, the motor and the supply network determine the most appropriate starting method.

Direct-on-line (DOL) Starter

Direct on line starting is suitable for stable supplies and mechanically stiff and well dimensioned systems. It is the simplest, cheapest and most common starting method. Starting equipment for small motors that do not start and stop frequently is simple, often consisting of a hand operated motor protection circuit breaker. Larger motors and motors that start and stop frequently, or have some kind of control system, normally use a direct-on-line starter which can consist of a contactor plus overload protection, such as a thermal relay.

Star-Delta (Y/Δ) Starter

This kind of starters used to first start the motor with the winding connected in star and then switch for delta connection in running position. To limit the starting current surge, large induction motors are started at reduced voltage and then have full supply voltage reconnected when they run up to near rotated speed. Star Delta connection gives a low starting current of only about one third of that during direct-online starting, although this also reduces the starting torque to about 25%. The motor is started with \star connection and accelerated as far as possible, then switched to Δ connection.

Soft Starter

Soft starters are based on semiconductors, which, via a power circuit and a control circuit, initially reduce the motor voltage, resulting in lower motor torque. During the starting process, the soft starter progressively increases the motor voltage so that the motor becomes strong enough to accelerate the load to rated speed without causing torque or current peaks. Soft starters can also be used to control the stopping of a process. Soft starters are less costly than frequency converters but like frequency converters, they may inject harmonic currents into the grid, disrupting other processes.

Frequency Converter Starter

The frequency converter is designed for continuous feeding of motors can also be used exclusively for start-up only. The frequency converter enables low starting current because the motor can produce rated torque at rated current from zero to full speed. As the price of frequency converters continues to drop, they are increasingly replacing soft starters. However in most cases they are still more expensive than soft starters, and like these, they inject harmonic currents into the network.

INSULATION SYSTEM TEMPERATURE CLASS

Electrical insulation systems are rated by standard NEMA (National Electrical Manufacturers Association) classifications according to maximum allowable operating temperature:

Temperature Tolerance Class	Maximum Operation Temperature Allowed		Allowable Temperature Rise at full load 1.0 service factor motor	Allowable Temperature Rise 1.15 service factor motor
	°C	°F	°C	°C
A	105	221	60	70
B	130	266	80	90
F	155	311	105	115
H	180	356	125	-

$$* T(^{\circ}F) = [T(^{\circ}C)](9/5) + 32$$

1) Allowable temperature rises are based upon a reference ambient temperature of 40°C. Operation temperature is reference temperature + allowable temperature rise + allowance for "hot spot" winding.

Example Temperature Tolerance Class F:

$$40^{\circ}C + 105^{\circ}C + 10^{\circ}C = 155^{\circ}C$$

In general a motor should not operate with temperatures above the maximum. Each 10°C rise above the rating may reduce the motor life time by one half. It is important to be aware that insulation classes are directly related to motor life.



Zirantec

Fabbrica Italiana Pompe Sommergibili S.r.l.

Viale Toscana, 46 - 20089 Rozzano (MI)

Tel. (+39) 02 8258923 - 02 57510371 Fax 02 57512095

E-mail: info@fips-pumps.it

www.zirantec.com; www.fips-pumps.it