

**Horizontal Split Case Pump
FSCW Series - 50 Hz**

Zirantec

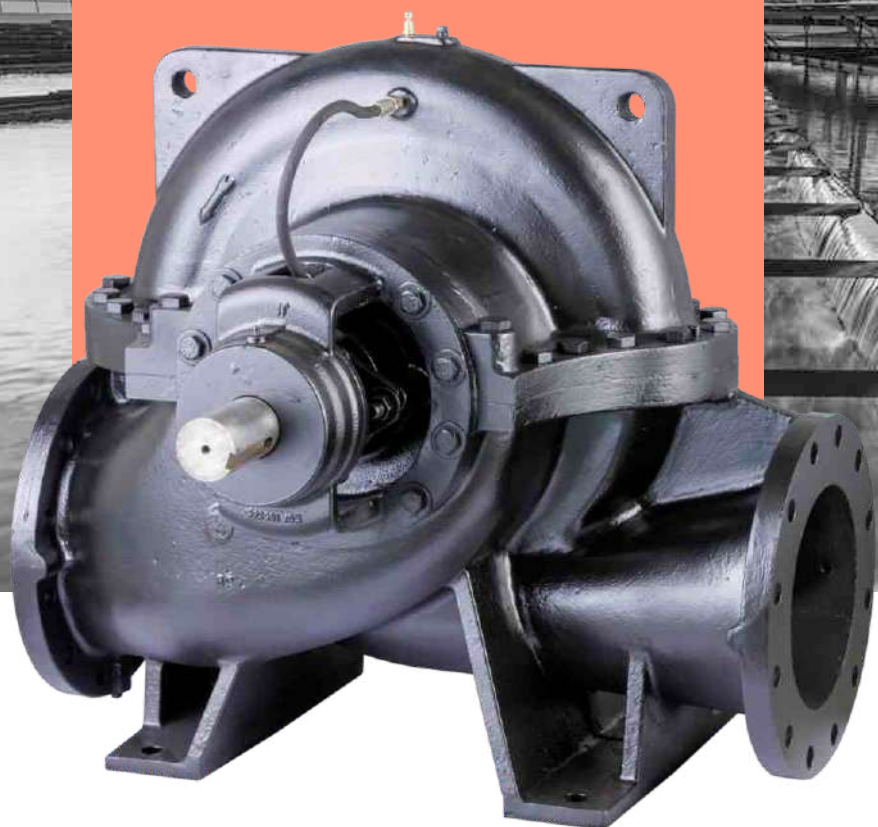

www.zirantec.com

Zirantec



ZIRANTEC products are manufactured by well qualified and experienced Italian Pump Engineers in state of the art manufacturing facilities in Italy

CERTIFICATION



ZIRANTEC Pumps & Motors are from the house of **Fabbrica Italiana Pompe Sommergibili S.r.l.** a four decades old Italian company of high repute, offering complete waste water solutions around the world. Its current product portfolio includes world class Waste Water Pumps of various types, Multistage Centrifugal Pressure Booster Pumps, Borehole Submersible Pumps & Motors, End Suction Centrifugal Pumps, Industrial Pumps for various applications.

Founded as early as 1978 in Rozzano, South of Milan, Italy by Mr.Orfeo Agostini, the company has witnessed steady growth and market expansion continuously ever since. In these four decades of existence, the company has carved a niche for itself in the waste water and sewage pump market in Italy and other countries. Its products are employed in Municipal, Domestic and Industrial applications. The Company is well known for the unique and robust designs of its products and their workmanship. Due to its superior quality ZIRANTEC products are also exported to many European, African and Asian countries.

ZIRANTEC's products are conceived, designed and manufactured by well qualified and experienced Italian Pump Engineers in state of the art manufacturing facilities in Italy. These manufacturing plants are accredited with UNI EN ISO 9001:2008 Certification.

Over the years, the company has metamorphosed and ventured into manufacturing of high quality water pumps, for domestic, agricultural and industrial applications. In the due process, Fabbrica Italiana Pompe Sommergibili S.r.l. has shed its image of an exclusive sewage and waste water pumps manufacturer to a complete pump production company with an ability to manufacture diverse kinds of pumps for different applications.

C O N T E N T S

PageNo.

HORIZONTAL SPLIT CASE PUMP - FSCW SERIES	
Model Identification Code	3
Description, Features & Applications	4
Family Curve	5
Performance Curve	6-61
Gland Packing Construction	62
Mechanical Seal Construction - Cartridge type	63
Mechanical Seal Construction - Bellow type	64
Interchangeability Chart	65-66
Bare Shaft Pump Dimensions	67-68
Pump Set Dimensions	69-74

MODEL IDENTIFICATION CODE

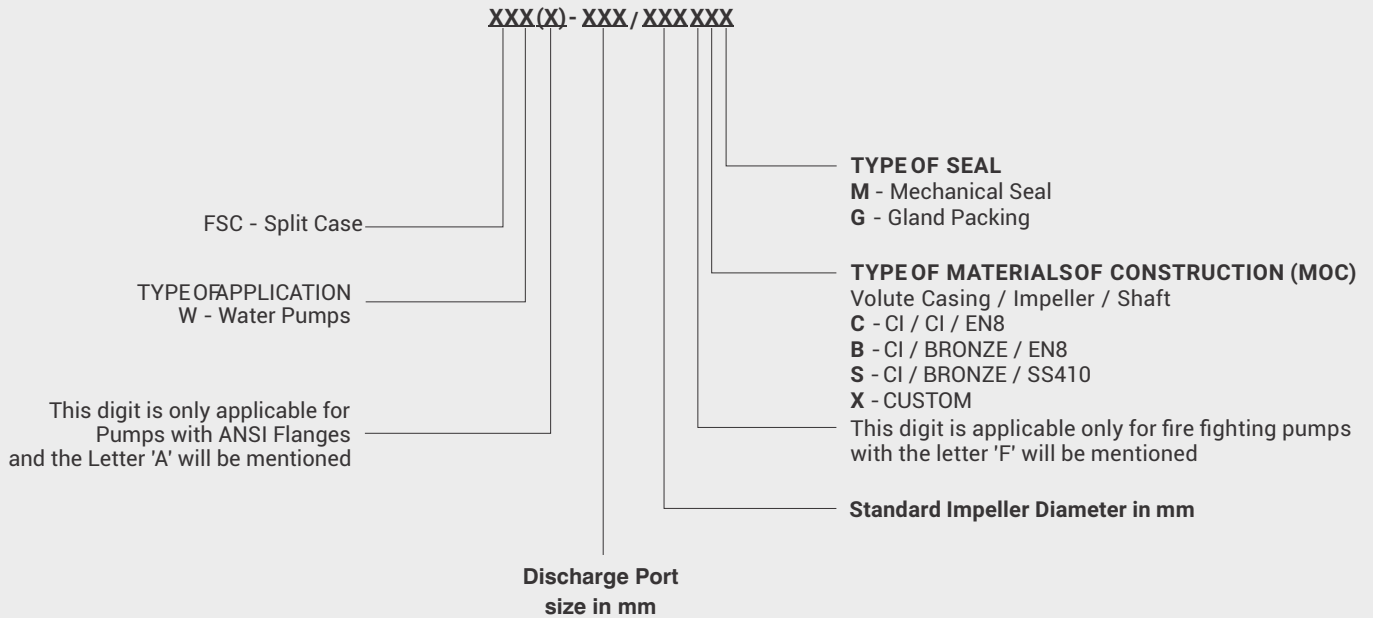

Example : FSCW-80/285 CG

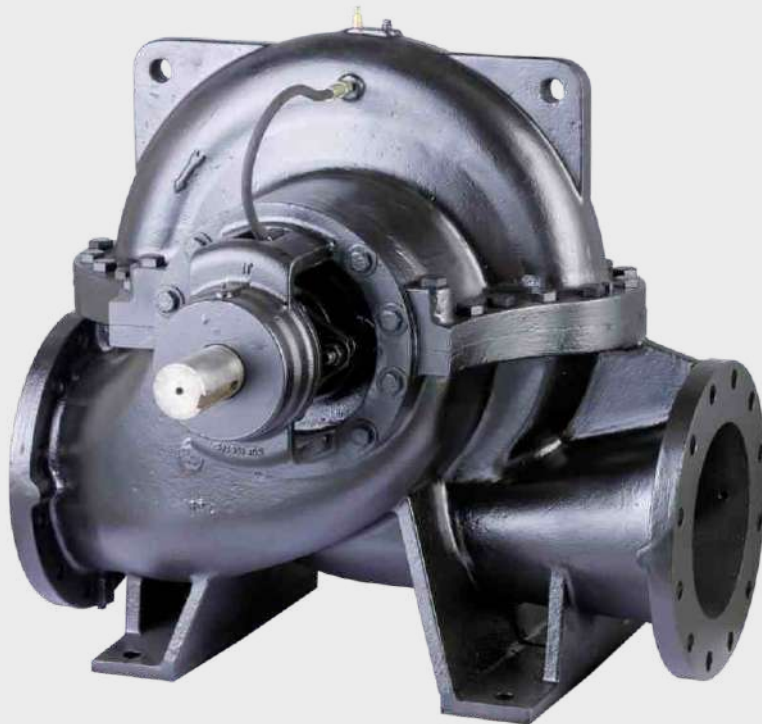

HORIZONTAL SPLIT CASE PUMP FSCW SERIES

Horizontal Split Case single stage double suction centrifugal pumps are designed to deliver higher rate of flow at designed operating head. Double suction impeller with between bearing design provides hydraulic balance, hence eliminating axial thrust. The casing is split axially with opposing suction and discharge flanges greatly simplifying maintenance. The inline suction and discharge nozzles are cast in the lower half casing. This design makes it easy to remove the upper casing and rotary components without disturbing the motor and pipe work.

DESIGN FEATURES

- Top Pull out design.
- Entire rotating unit assembly can be removed without disturbing pipe connection and prime mover.
- Rigid and balanced design
- Low NPSH double suction impeller.
- Common housing for gland & mechanical seal.
- Replaceable wear rings.

APPLICATIONS

- Utility water supply in commercial buildings
- Heating ventilation and air-conditioning system
- Industry
- Auxiliary and circulating cooling water supply
- Cooling tower application in Industries
- Water Treatment plants
- Water transfer & boosting
- Flood control

OPERATING DATA

Flow	Upto 4200 m ³ /hr
Head	Upto 122 m
Power Range	Upto 1460 kW
Liquid Temperature	Upto 90°C
Outlet size	Upto 450 mm
Working Pressure	Upto 16 bar
MOC	CI, Bronze, Stainless Steel

PERFORMANCE CURVE

Pump Model : FSCW-80/220

Pump Size in mm : 100 x 80 x 220

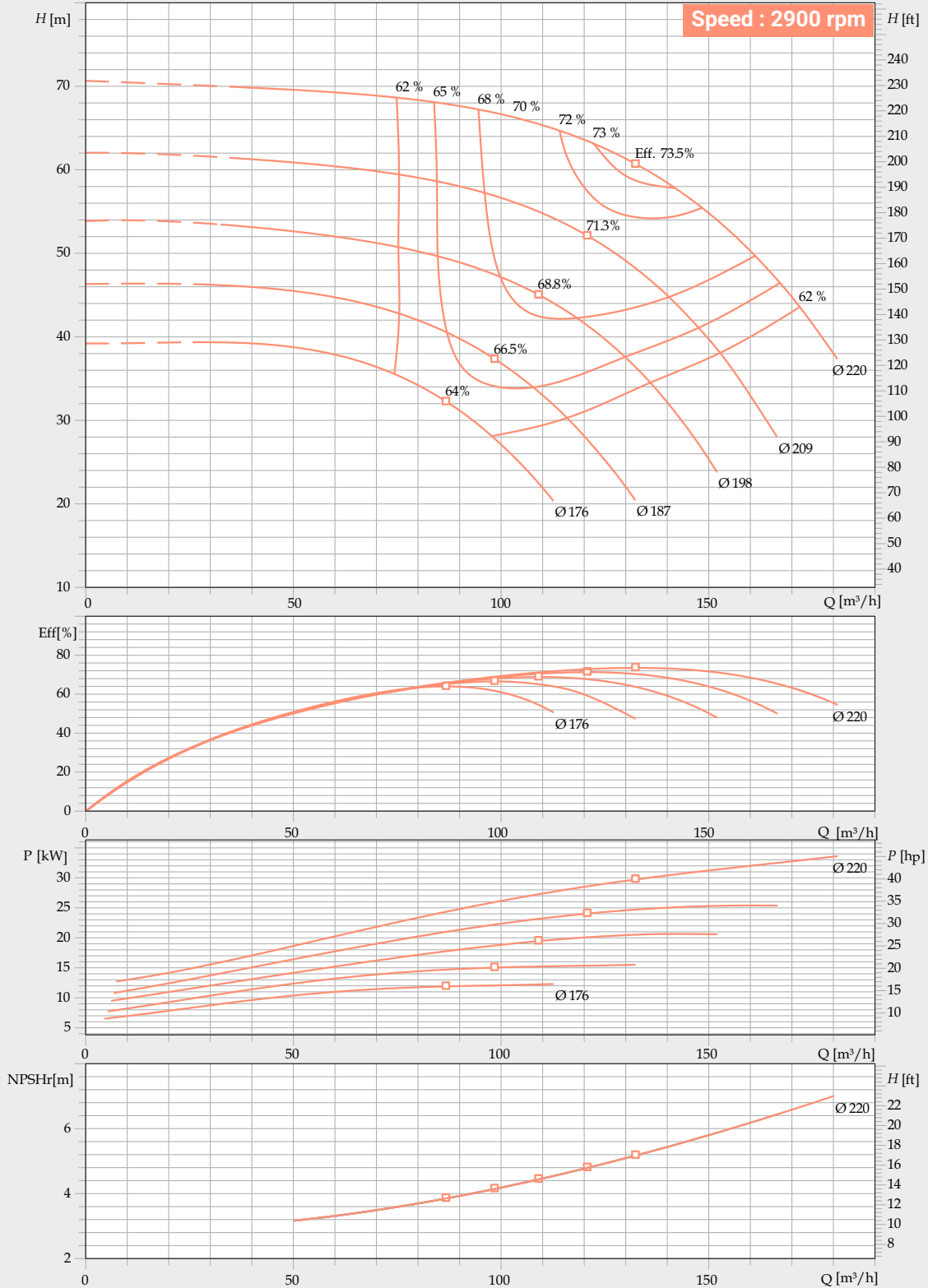

Performance to tolerance as per ISO 9906 Grade 2B.

For safety kindly consider a margin of 0.5m higher of NPSH.

In view of continuous development, the informations / descriptions / specification / illustration are subjected to change without notice.

PERFORMANCE CURVE

Pump Model : **FSCW-80/285**

Pump Size in mm : **80 x 80 x 285**

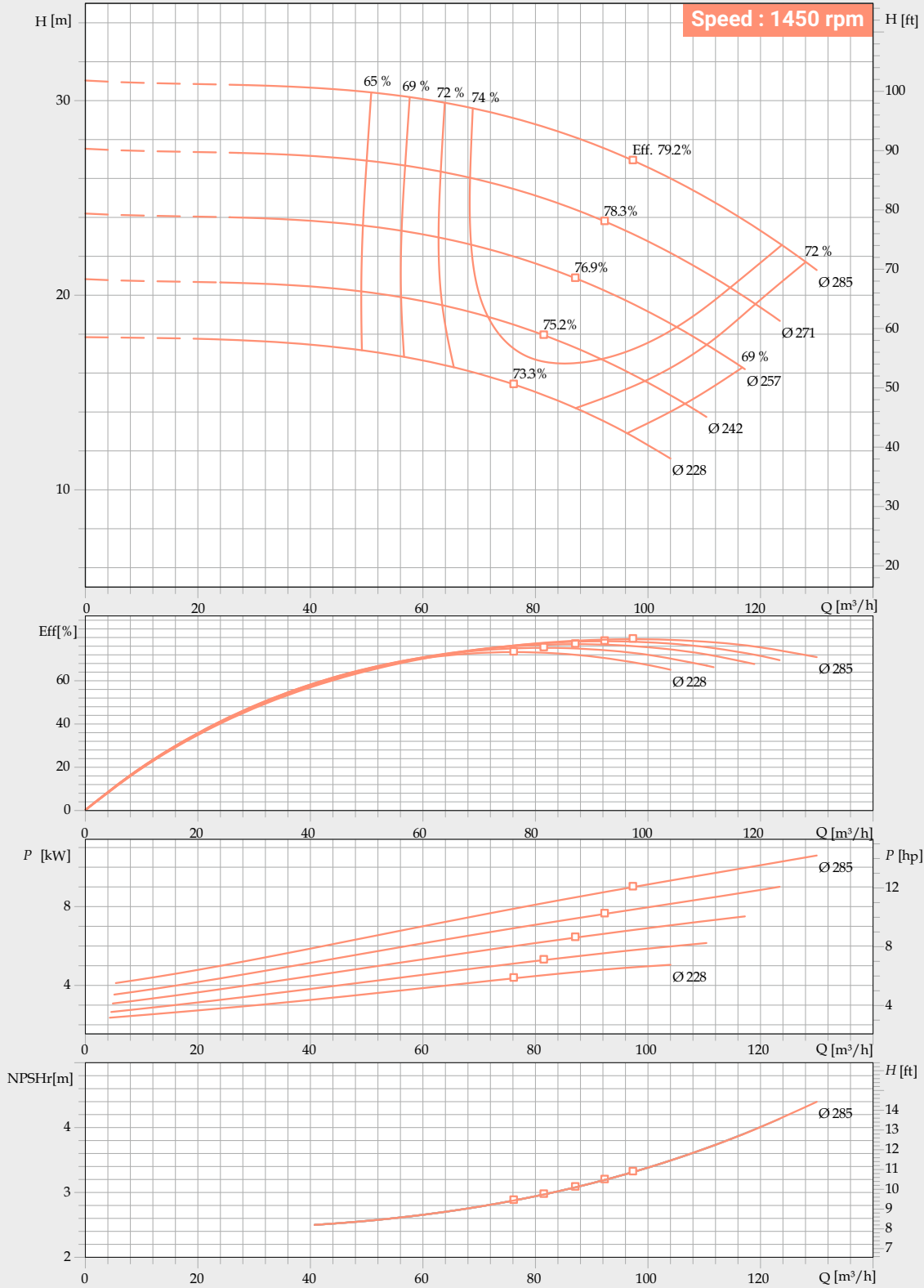

Performance to tolerance as per ISO 9906 Grade 2B.
 For safety kindly consider a margin of 0.5m higher of NPSH.
 In view of continuous development, the informations / descriptions / specification / illustration are subjected to change without notice.

PERFORMANCE CURVE

Pump Model : **FSCW-80/340**

Pump Size in mm : **100 x 80 x 340**

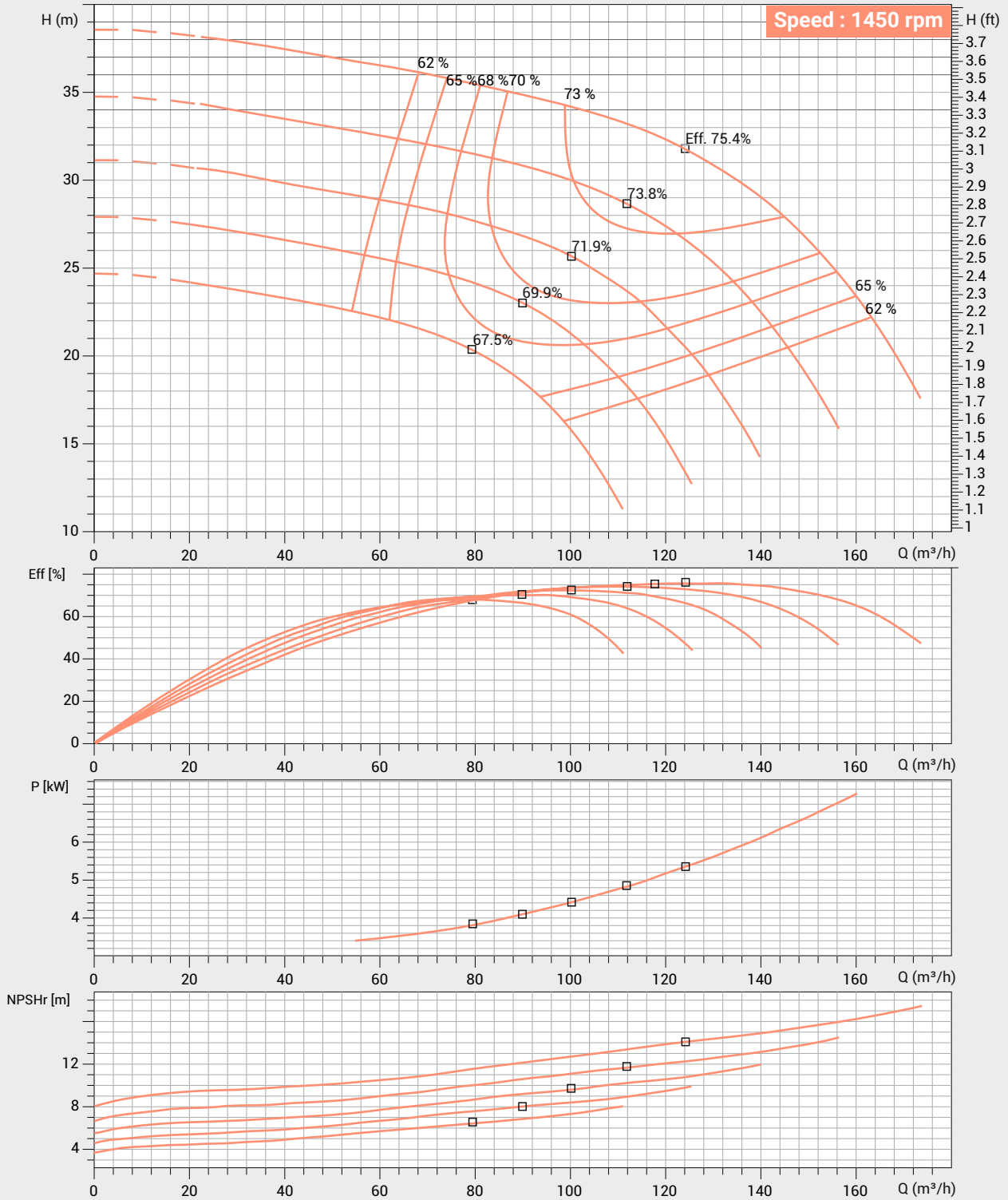

Performance to tolerance as per ISO 9906 Grade 2B.

For safety kindly consider a margin of 0.5m higher of NPSH.

In view of continuous development, the informations / descriptions / specification / illustration are subjected to change without notice.

PERFORMANCE CURVE

Pump Model : FSCW-100/250

Pump Size in mm : 125 x 100 x 250

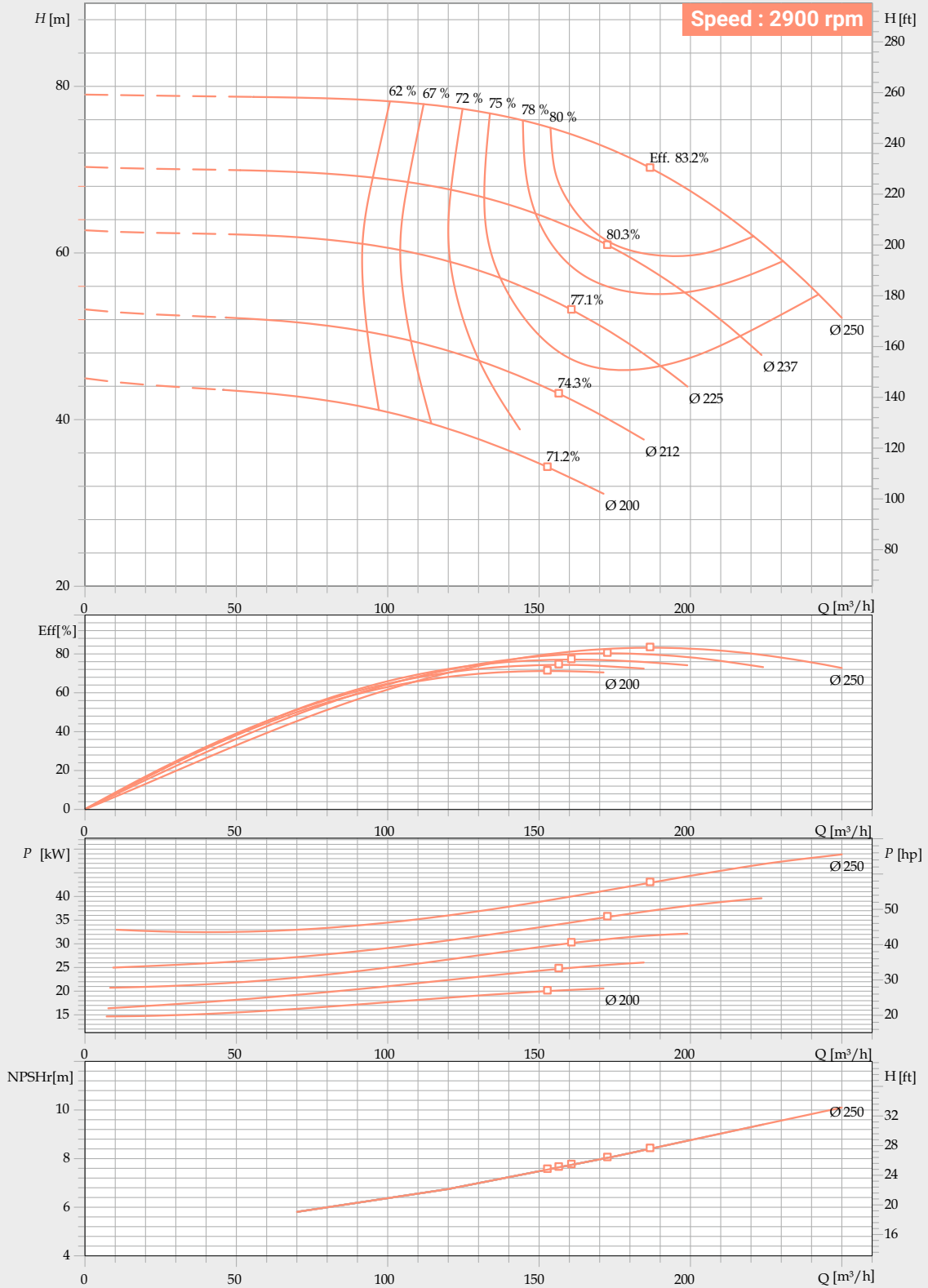

Performance to tolerance as per ISO 9906 Grade 2B.
 For safety kindly consider a margin of 0.5m higher of NPSH.
 In view of continuous development, the informations / descriptions / specification / illustration are subjected to change without notice.

PERFORMANCE CURVE

Pump Model : FSCW-100/280

Pump Size in mm : 125 x 100 x 280

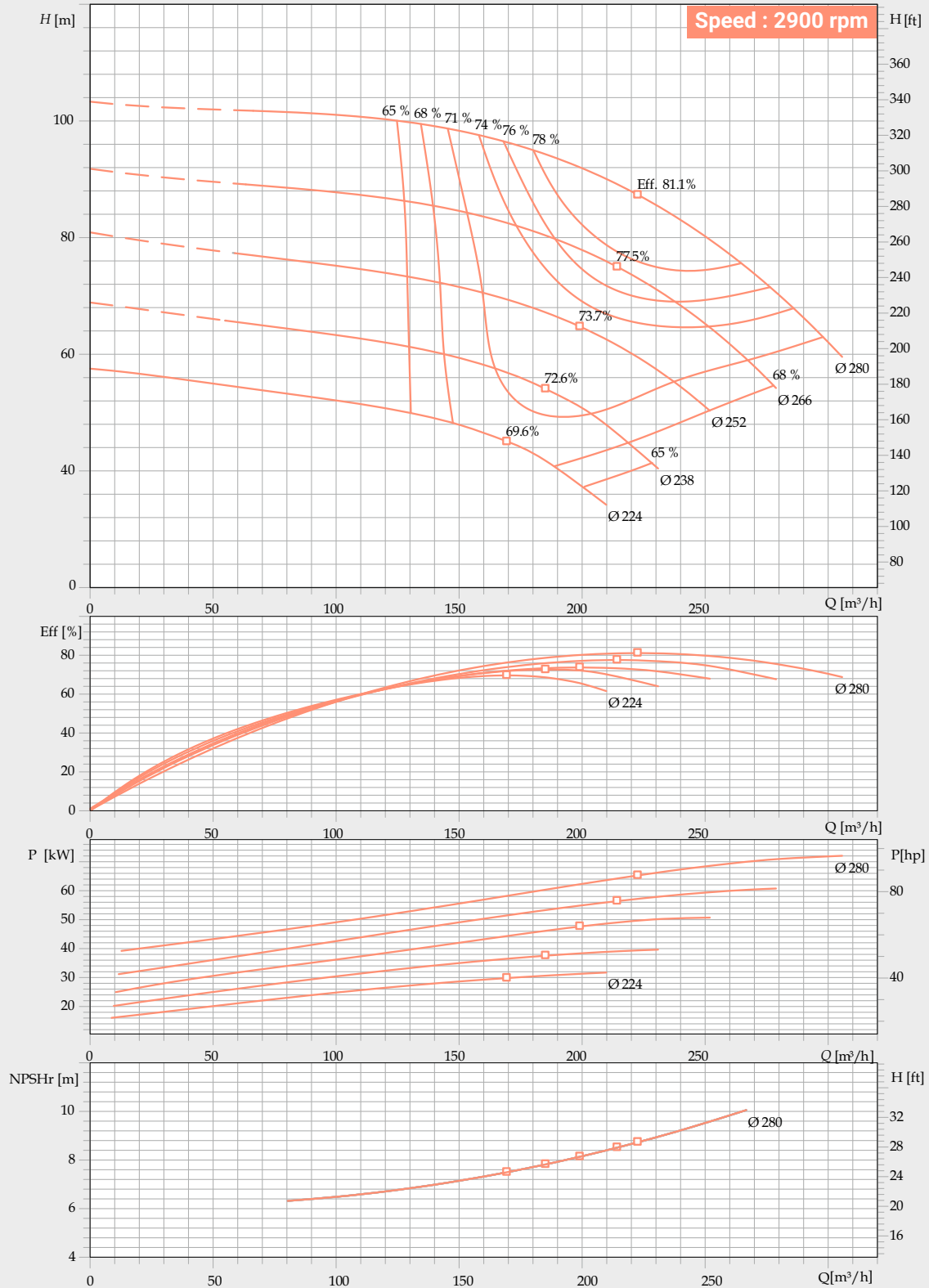

Performance to tolerance as per ISO 9906 Grade 2B.

For safety kindly consider a margin of 0.5m higher of NPSH.

In view of continuous development, the informations / descriptions / specification / illustration are subjected to change without notice.

PERFORMANCE CURVE

Pump Model : **FSCW-100/300**

Pump Size in mm : **100 x 100 x 300**

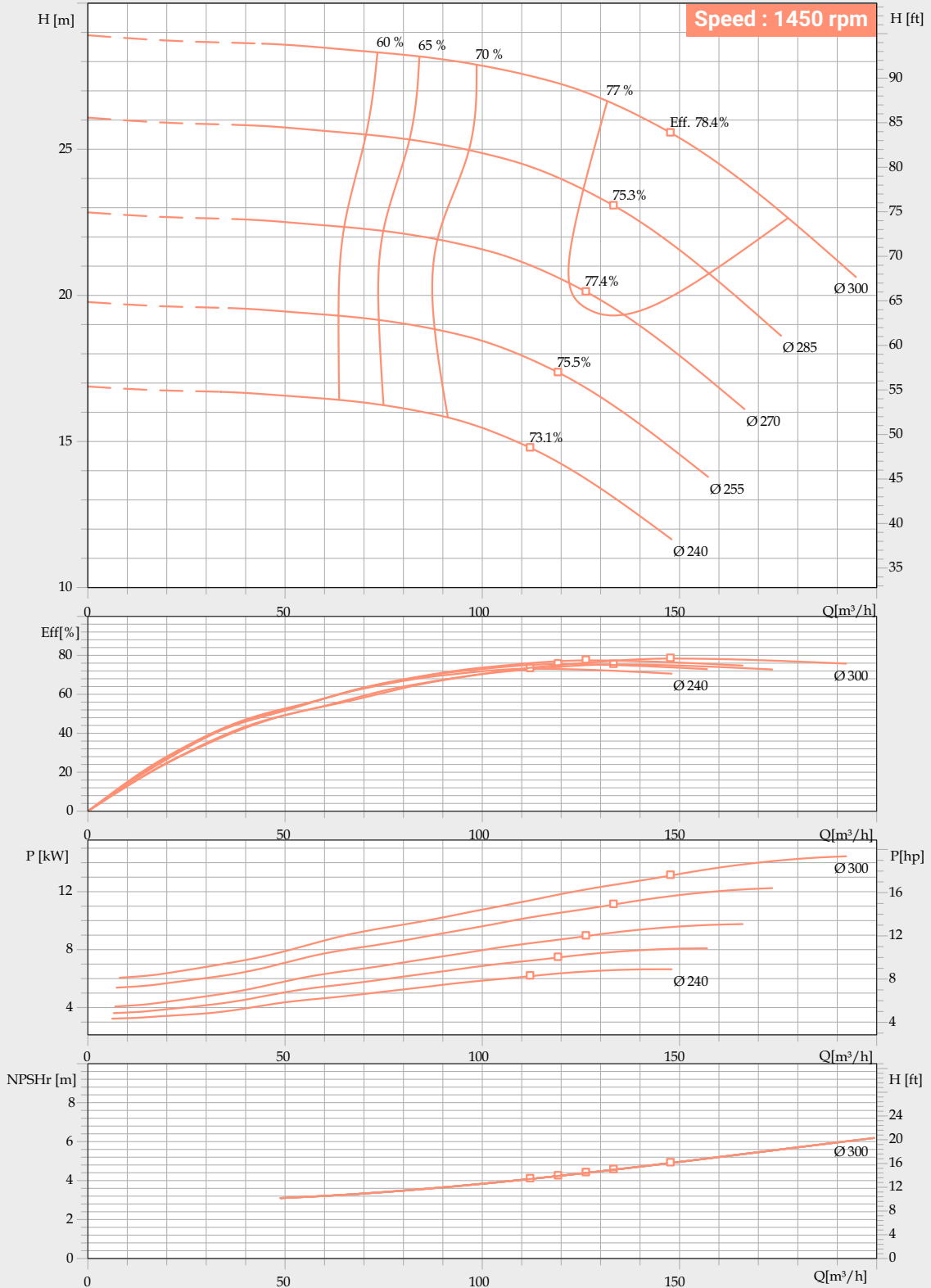

Performance to tolerance as per ISO 9906 Grade 2B.
 For safety kindly consider a margin of 0.5m higher of NPSH.
 In view of continuous development, the informations / descriptions / specification / illustration are subjected to change without notice.

PERFORMANCE CURVE

Pump Model : FSCW-100/305

Pump Size in mm : 125 x 100 x 305

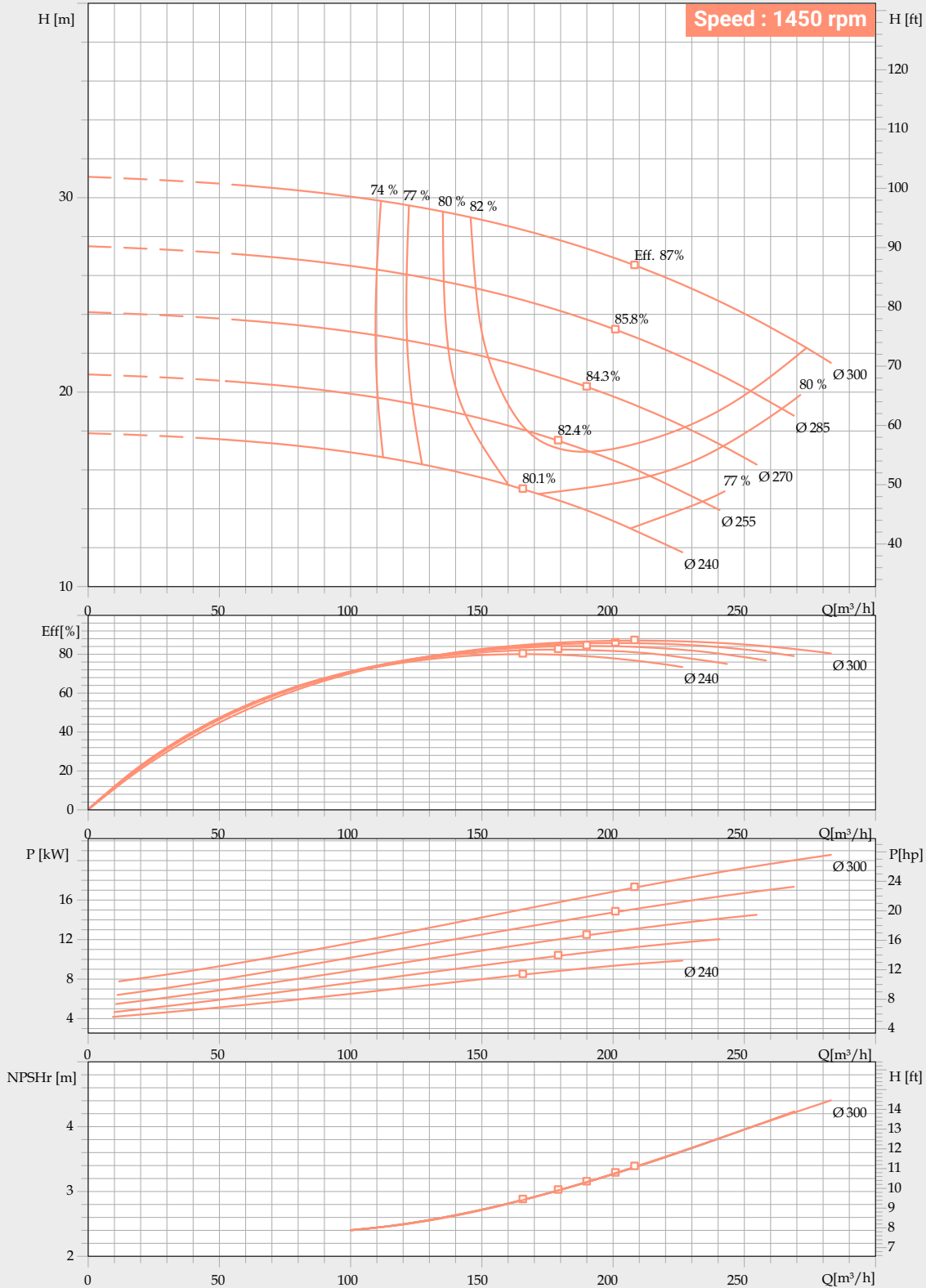

Performance to tolerance as per ISO 9906 Grade 2B.

For safety kindly consider a margin of 0.5m higher of NPSH.

In view of continuous development, the informations / descriptions / specification / illustration are subjected to change without notice.

PERFORMANCE CURVE

Pump Model : FSCW-100/320

Pump Size in mm : 100 x 100 x 320

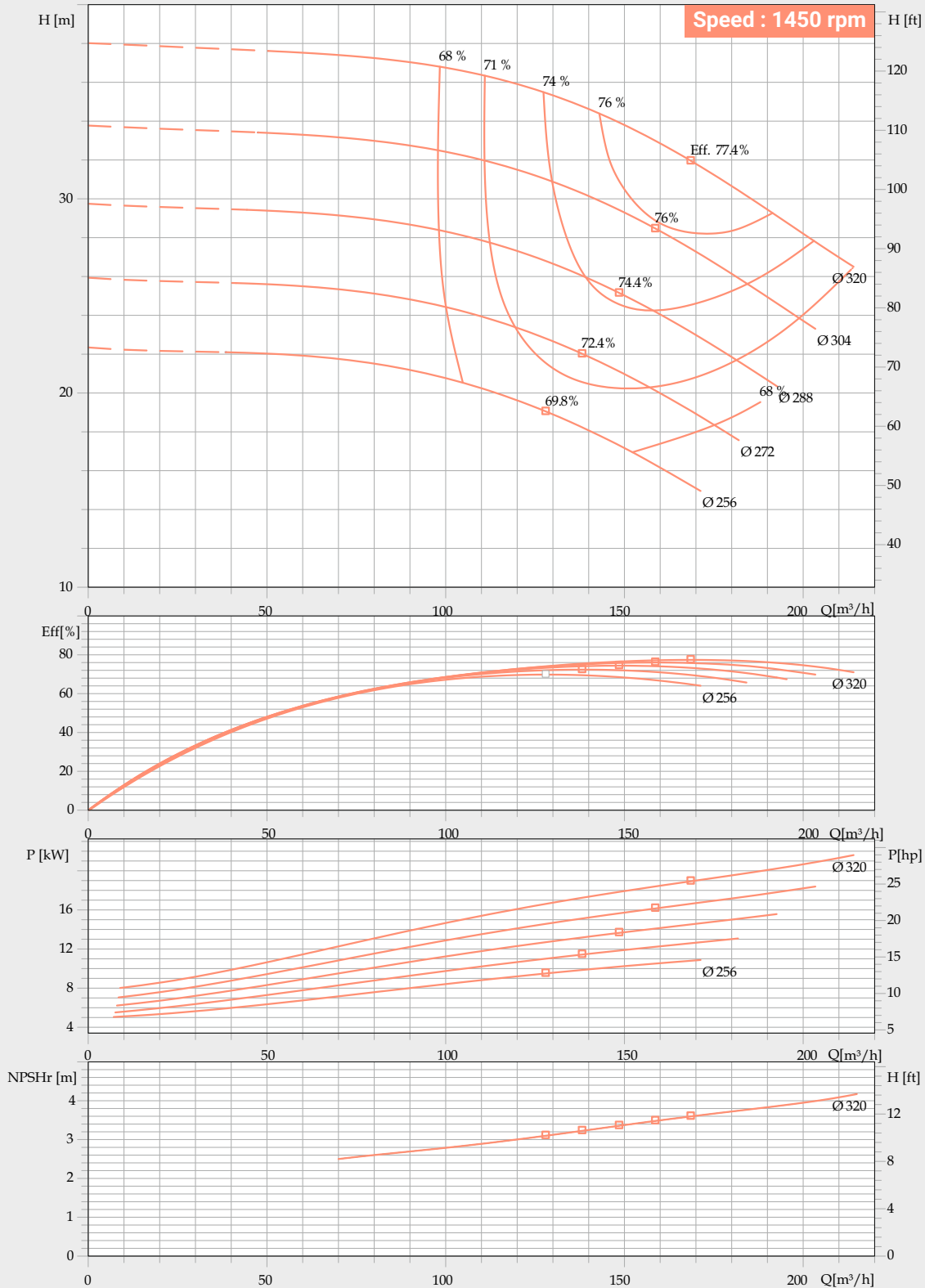

Performance to tolerance as per ISO 9906 Grade 2B.
 For safety kindly consider a margin of 0.5m higher of NPSH.
 In view of continuous development, the informations / descriptions / specification / illustration are subjected to change without notice.

PERFORMANCE CURVE

Pump Model : **FSCW-100/400**

Pump Size in mm : **125 x 100 x 400**

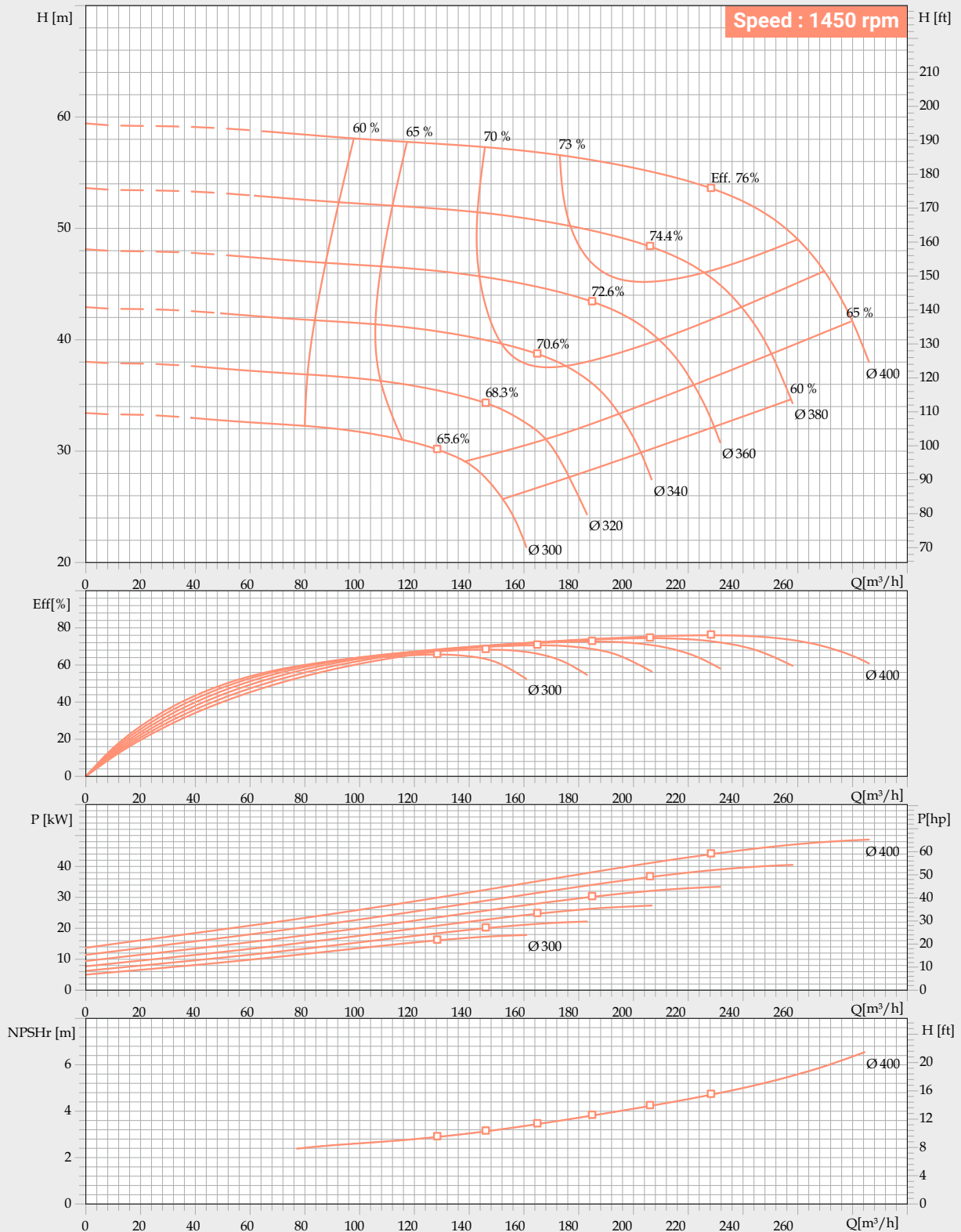

Performance to tolerance as per ISO 9906 Grade 2B.
 For safety kindly consider a margin of 0.5m higher of NPSH.
 In view of continuous development, the informations / descriptions / specification / illustration are subjected to change without notice.

PERFORMANCE CURVE

Pump Model : **FSCW-125/300**

Pump Size in mm : **150 x 125 x 300**

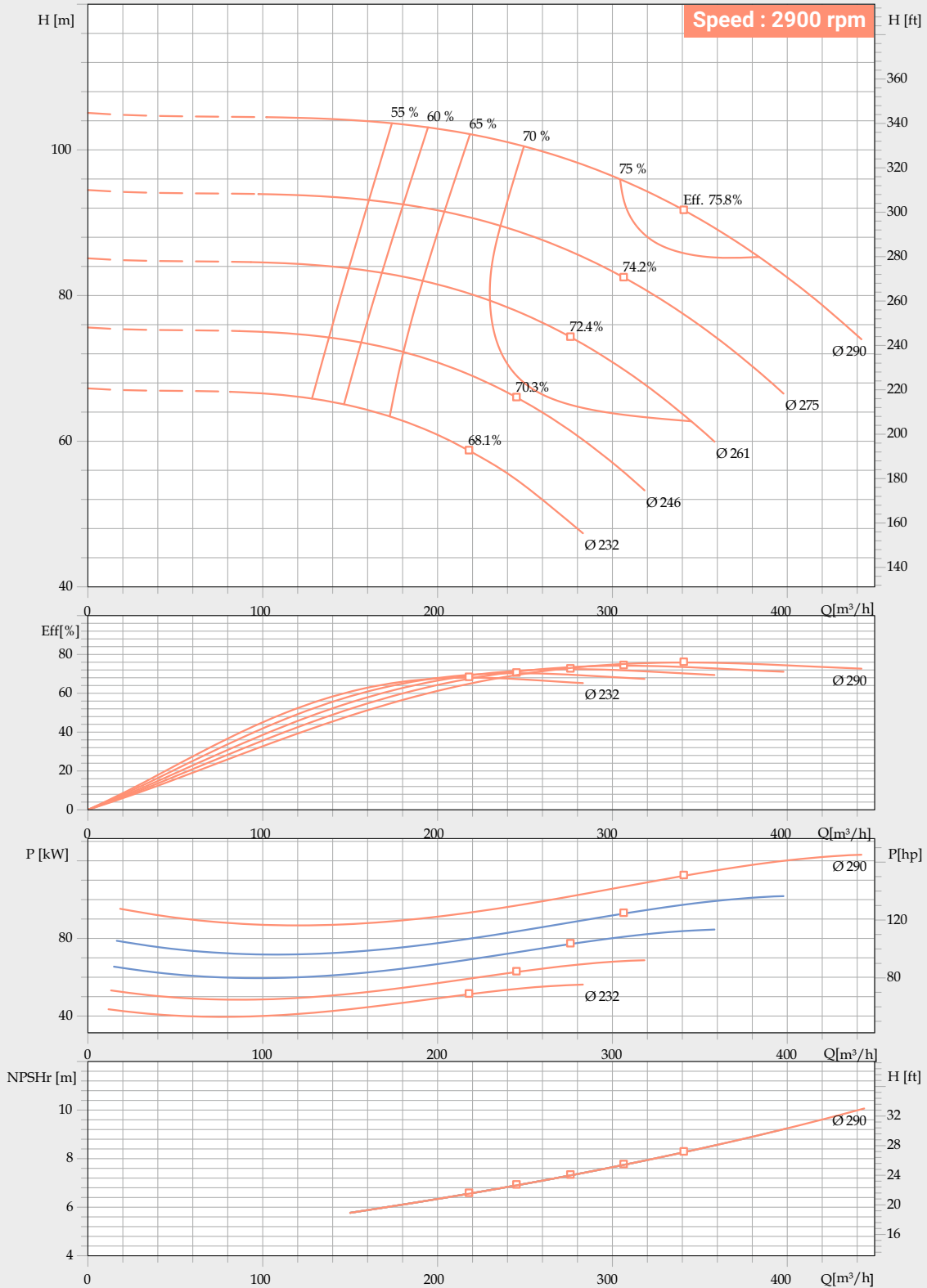

Performance to tolerance as per ISO 9906 Grade 2B.
 For safety kindly consider a margin of 0.5m higher of NPSH.
 In view of continuous development, the informations / descriptions / specification / illustration are subjected to change without notice.

PERFORMANCE CURVE

Pump Model : FSCW-125/335

Pump Size in mm : 125 x 125 x 335

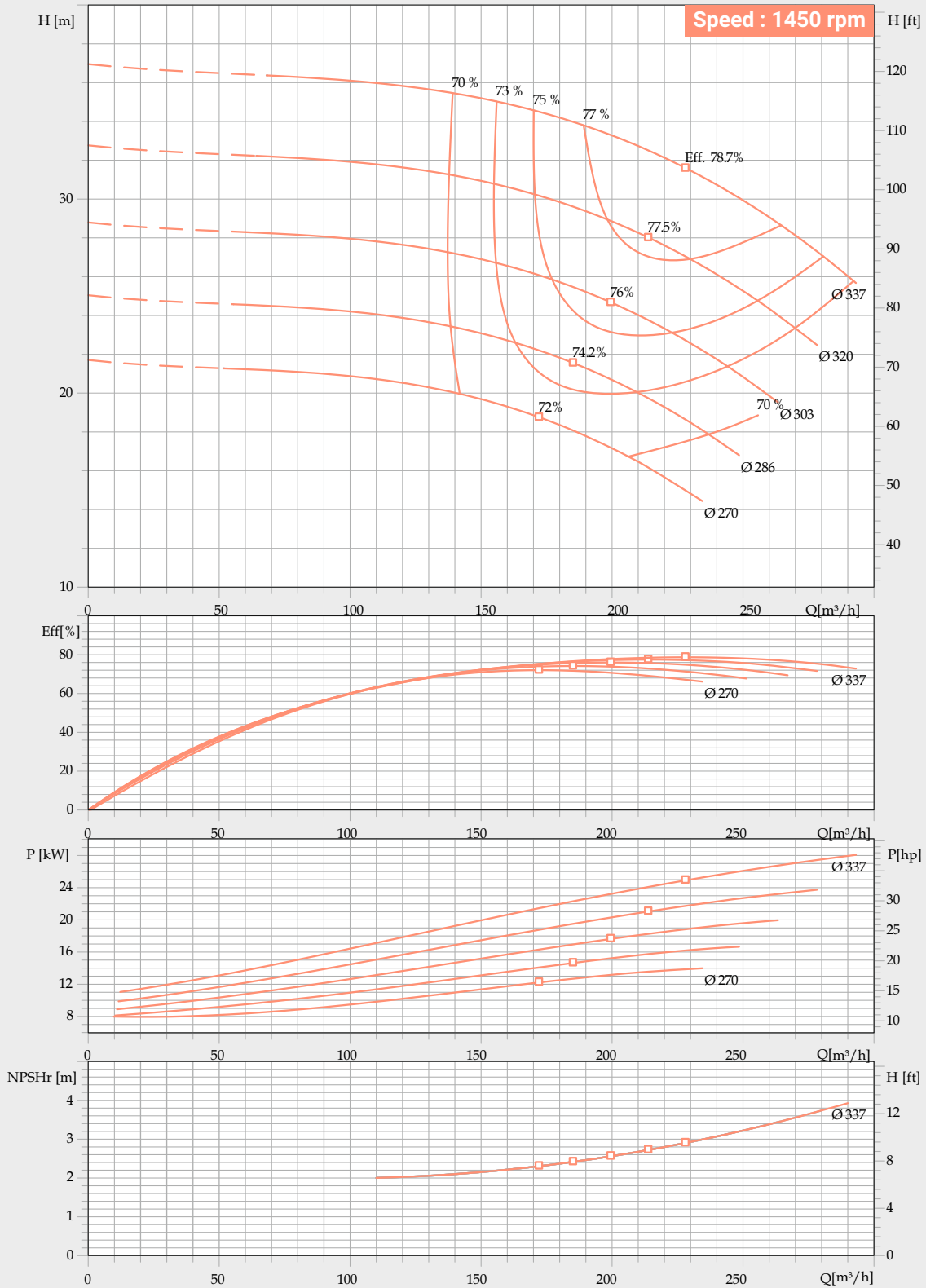

Performance to tolerance as per ISO 9906 Grade 2B.
 For safety kindly consider a margin of 0.5m higher of NPSH.
 In view of continuous development, the informations / descriptions / specification / illustration are subjected to change without notice.

PERFORMANCE CURVE

Pump Model : FSCW-125/340

Pump Size in mm : 150 x 125 x 340

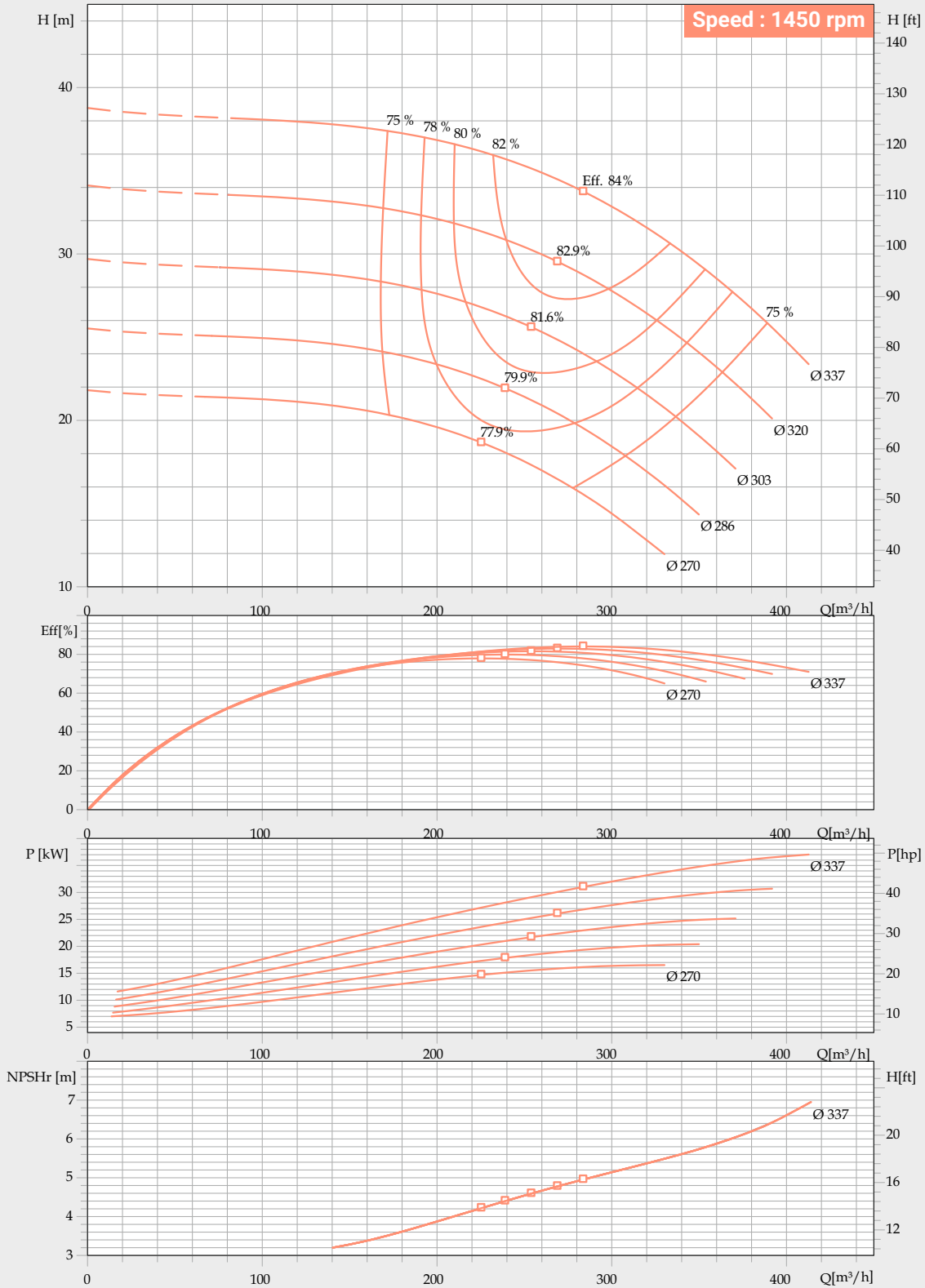

Performance to tolerance as per ISO 9906 Grade 2B.

For safety kindly consider a margin of 0.5m higher of NPSH.

In view of continuous development, the informations / descriptions / specification / illustration are subjected to change without notice.

PERFORMANCE CURVE

Pump Model : FSCW-125/360

Pump Size in mm : 150 x 125 x 360

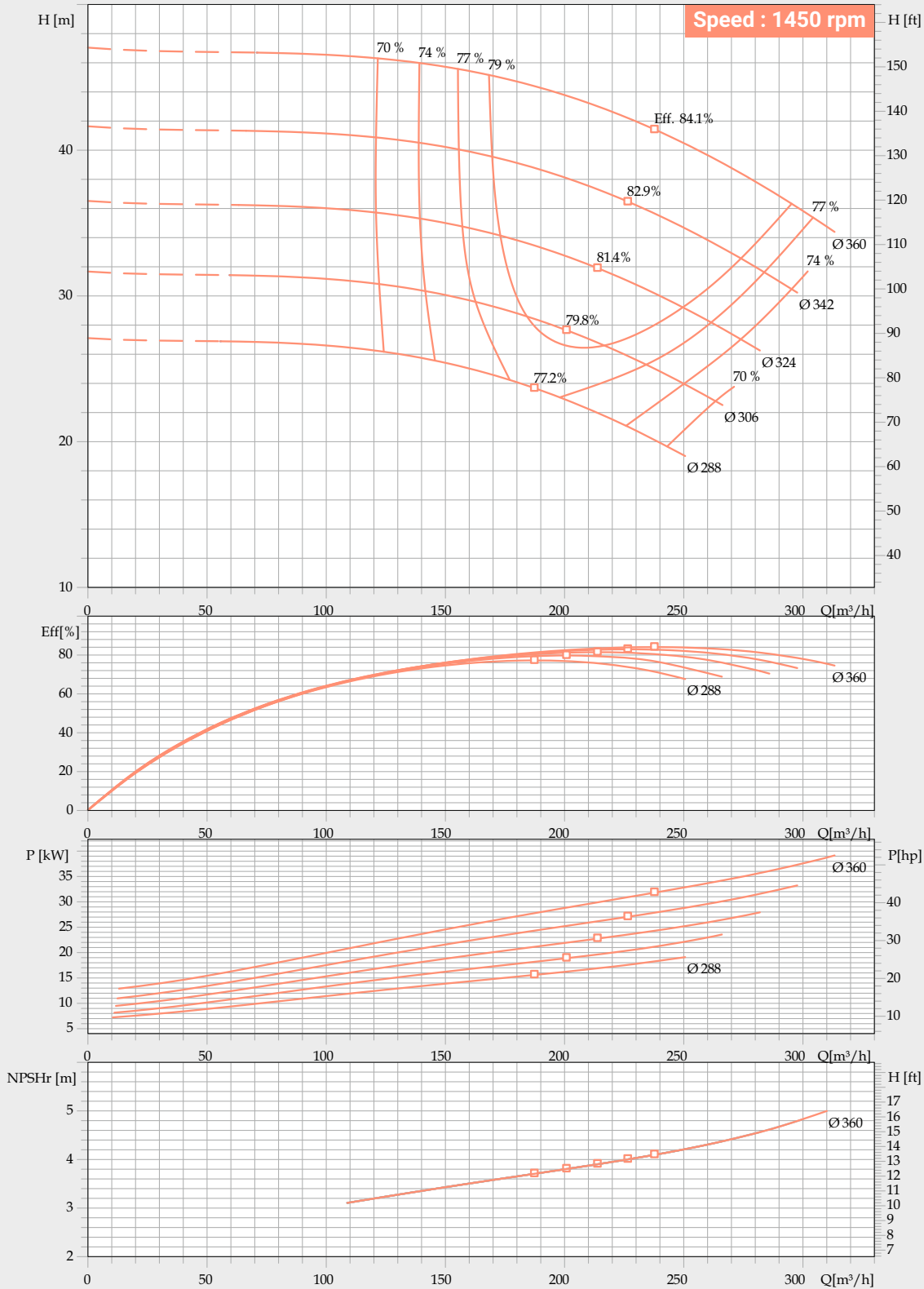

Performance to tolerance as per ISO 9906 Grade 2B.

For safety kindly consider a margin of 0.5m higher of NPSH.

In view of continuous development, the informations / descriptions / specification / illustration are subjected to change without notice.

PERFORMANCE CURVE

Pump Model : FSCW-125/380

Pump Size in mm : 150 x 125 x 380

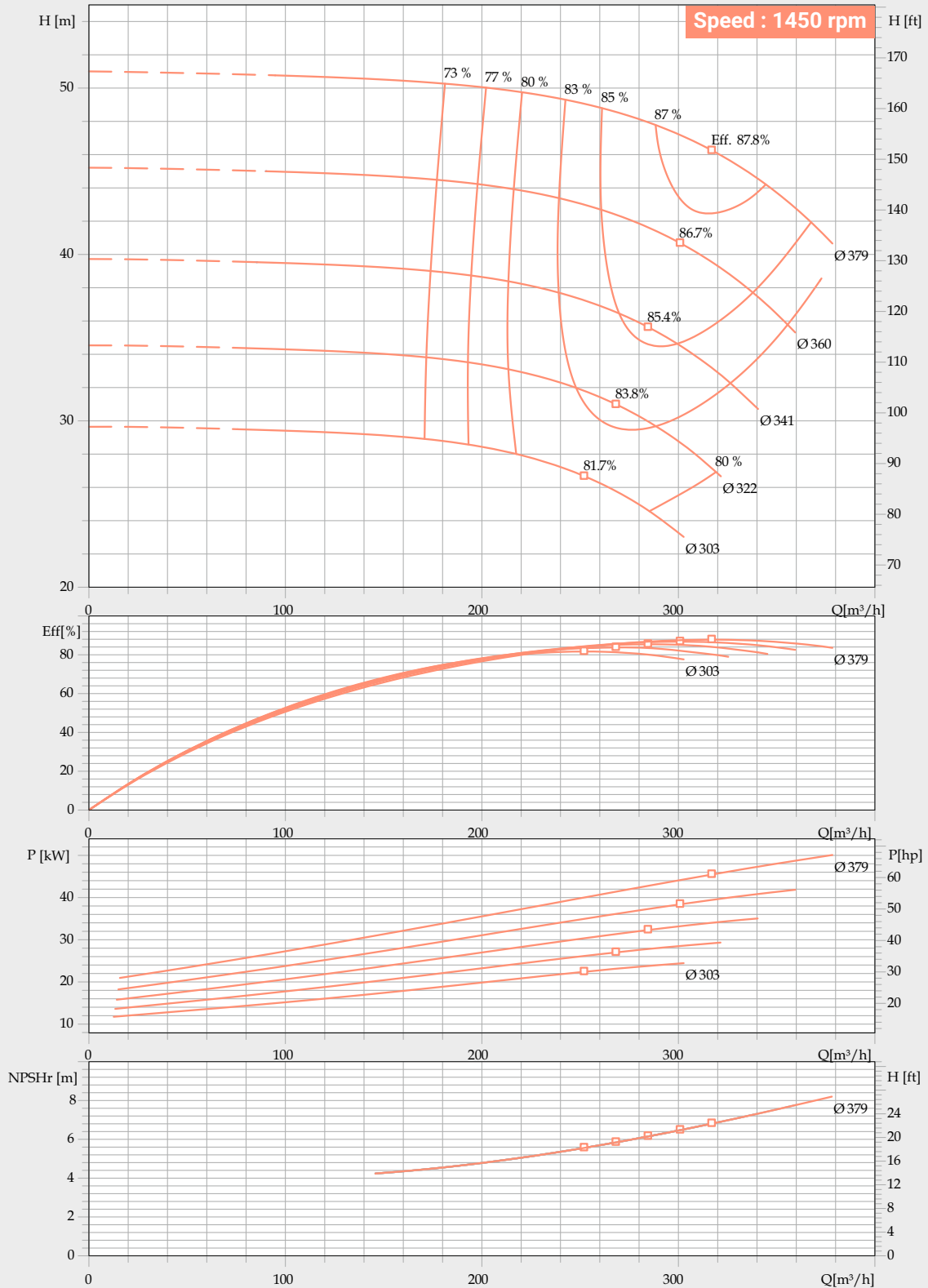

Performance to tolerance as per ISO 9906 Grade 2B.

For safety kindly consider a margin of 0.5m higher of NPSH.

In view of continuous development, the informations / descriptions / specification / illustration are subjected to change without notice.

PERFORMANCE CURVE

Pump Model : FSCW-125/400

Pump Size in mm : 150 x 125 x 400

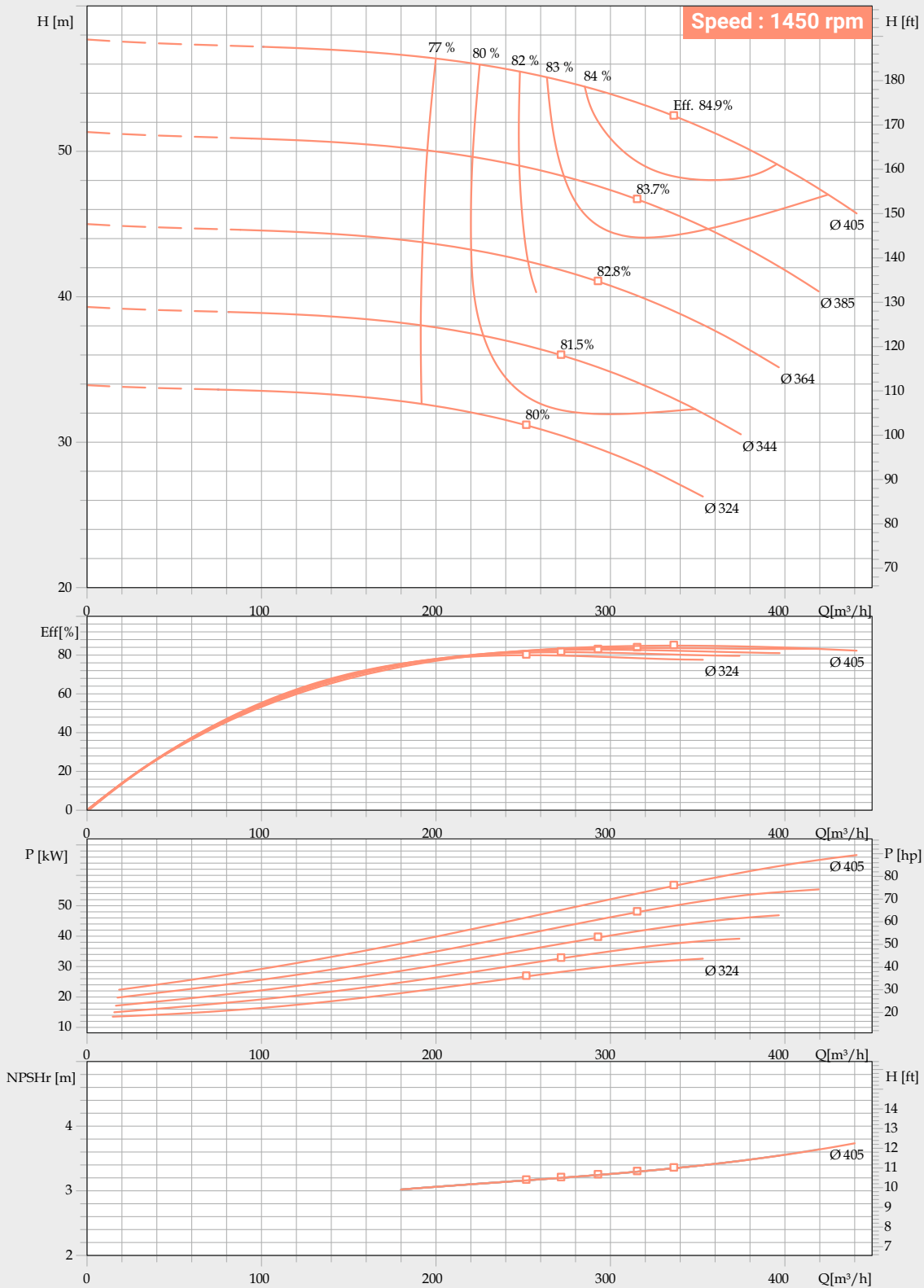

Performance to tolerance as per ISO 9906 Grade 2B.
 For safety kindly consider a margin of 0.5m higher of NPSH.
 In view of continuous development, the informations / descriptions / specification / illustration are subjected to change without notice.

PERFORMANCE CURVE

Pump Model : FSCW-125/440

Pump Size in mm : 150 x 125 x 440

Speed : 1450 rpm

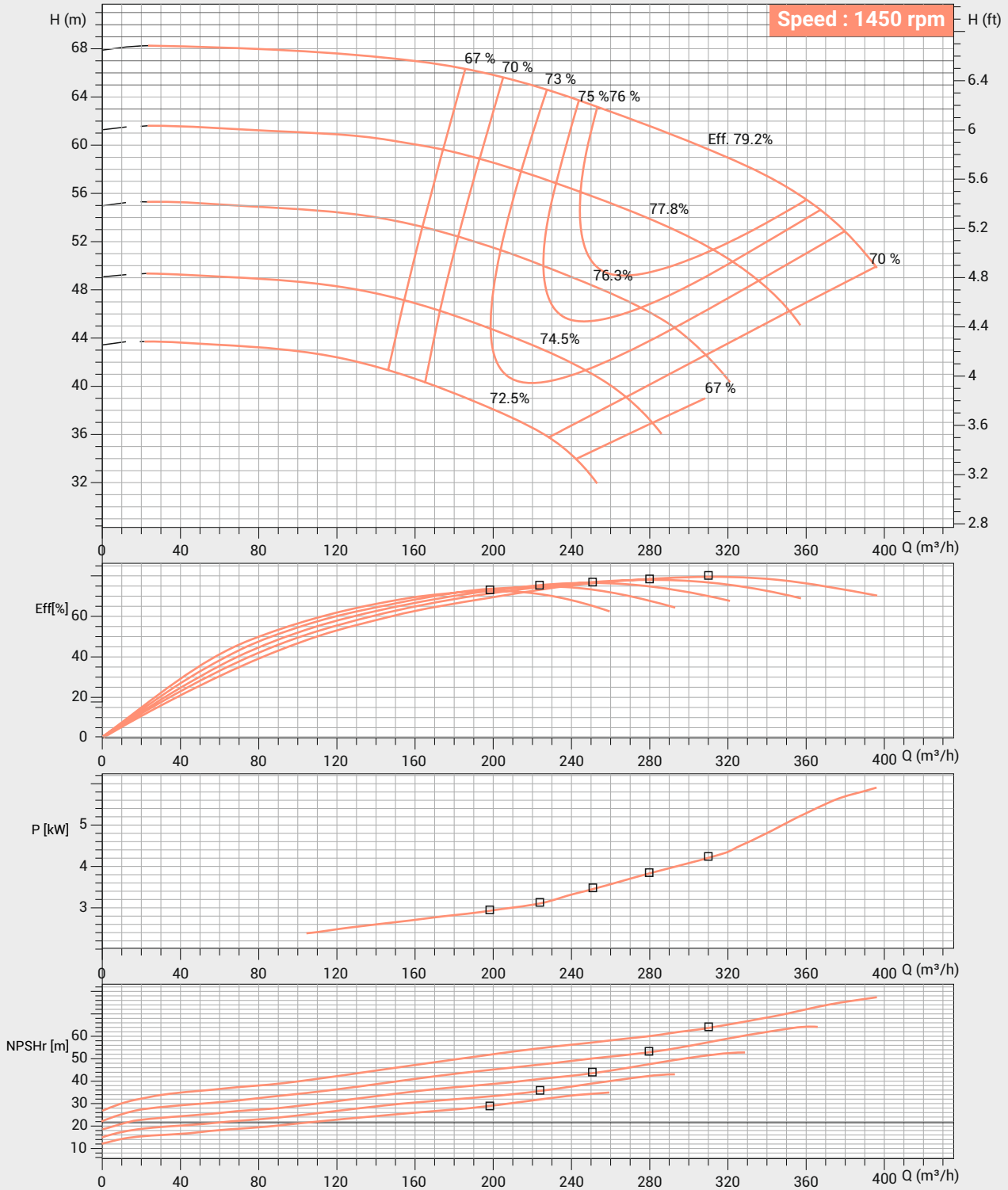

Performance to tolerance as per ISO 9906 Grade 2B.
 For safety kindly consider a margin of 0.5m higher of NPSH.
 In view of continuous development, the informations / descriptions / specification / illustration are subjected to change without notice.

PERFORMANCE CURVE

Pump Model : FSCW-125/470

Pump Size in mm : 150 x 125 x 470

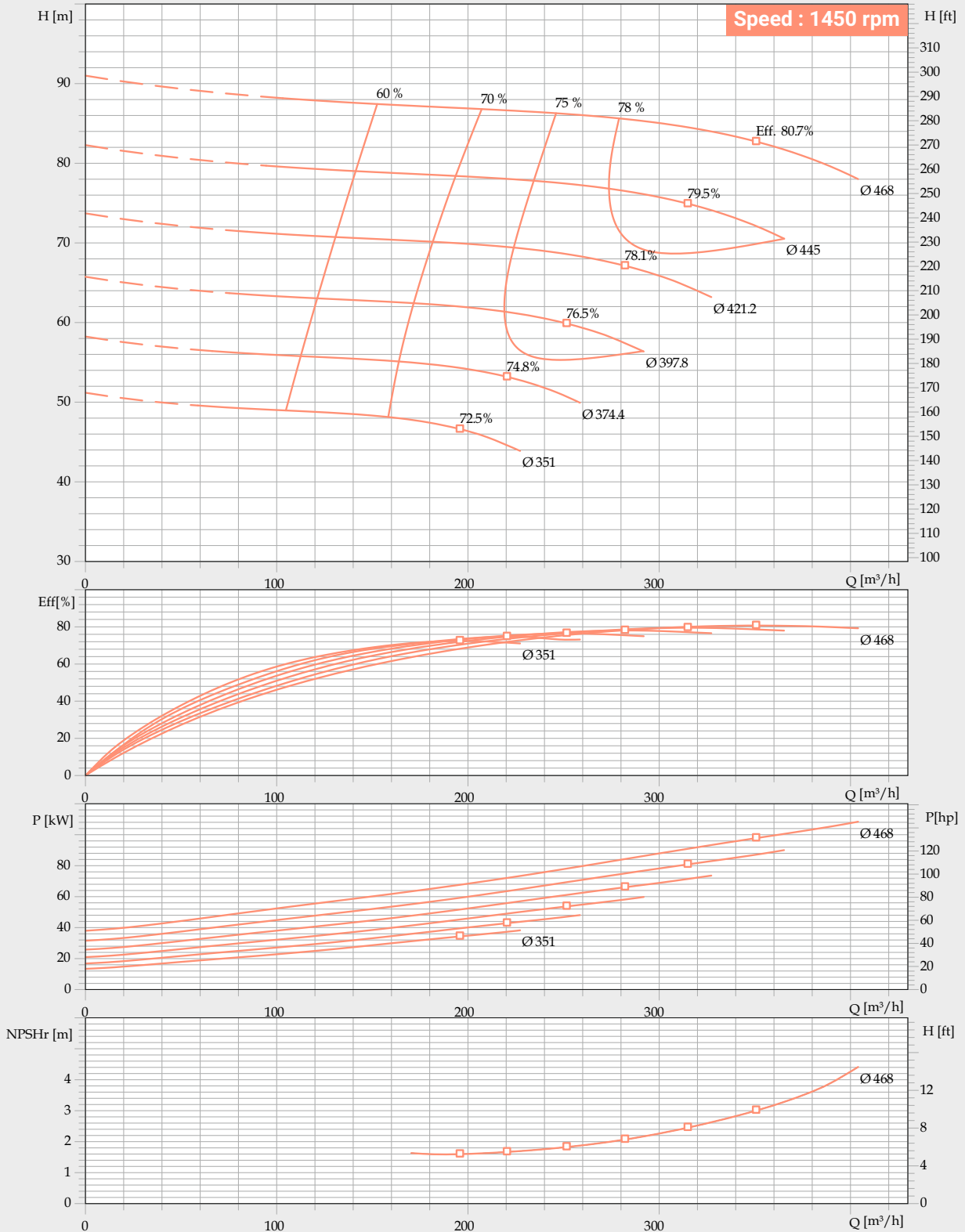

Performance to tolerance as per ISO 9906 Grade 2B.
 For safety kindly consider a margin of 0.5m higher of NPSH.
 In view of continuous development, the informations / descriptions / specification / illustration are subjected to change without notice.

PERFORMANCE CURVE

Pump Model : FSCW-150/300

Pump Size in mm : 150 x 150 x 300

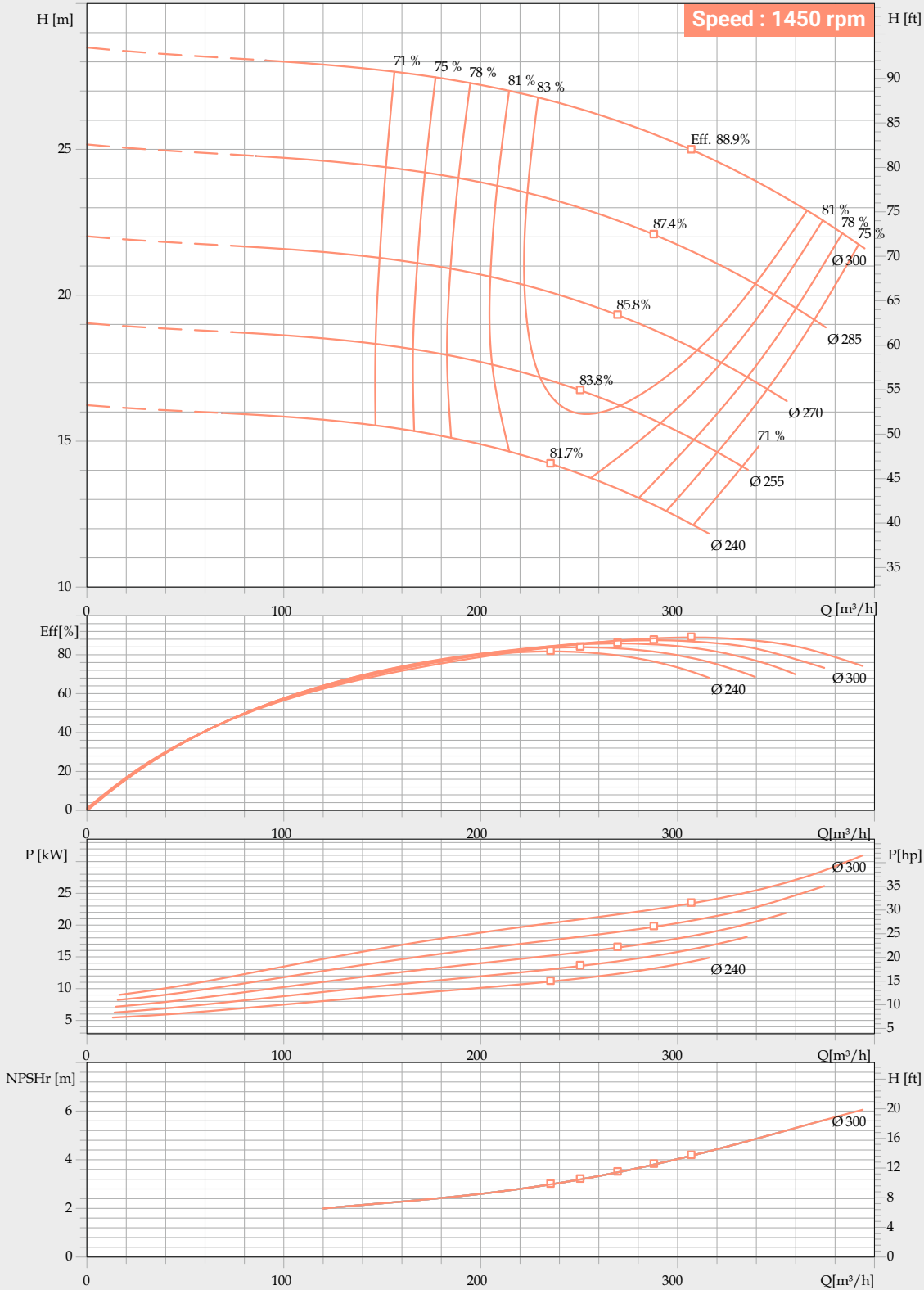

Performance to tolerance as per ISO 9906 Grade 2B.
 For safety kindly consider a margin of 0.5m higher of NPSH.
 In view of continuous development, the informations / descriptions / specification / illustration are subjected to change without notice.

PERFORMANCE CURVE

Pump Model : FSCW-150/305

Pump Size in mm : 200 x 150 x 305

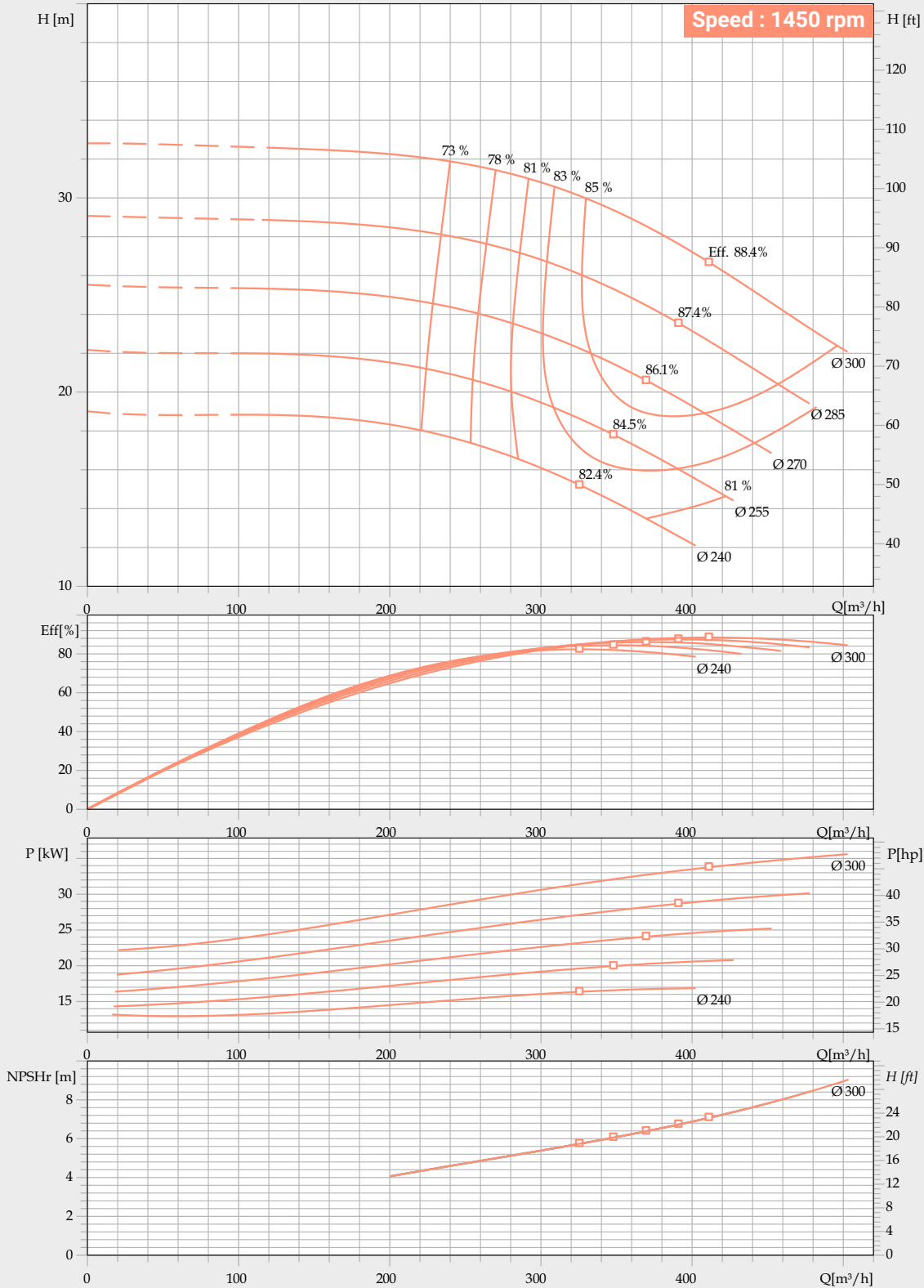

Performance to tolerance as per ISO 9906 Grade 2B.

For safety kindly consider a margin of 0.5m higher of NPSH.

In view of continuous development, the informations / descriptions / specification / illustration are subjected to change without notice.

PERFORMANCE CURVE

Pump Model : FSCW-150/320

Pump Size in mm : 200 x 150 x 320

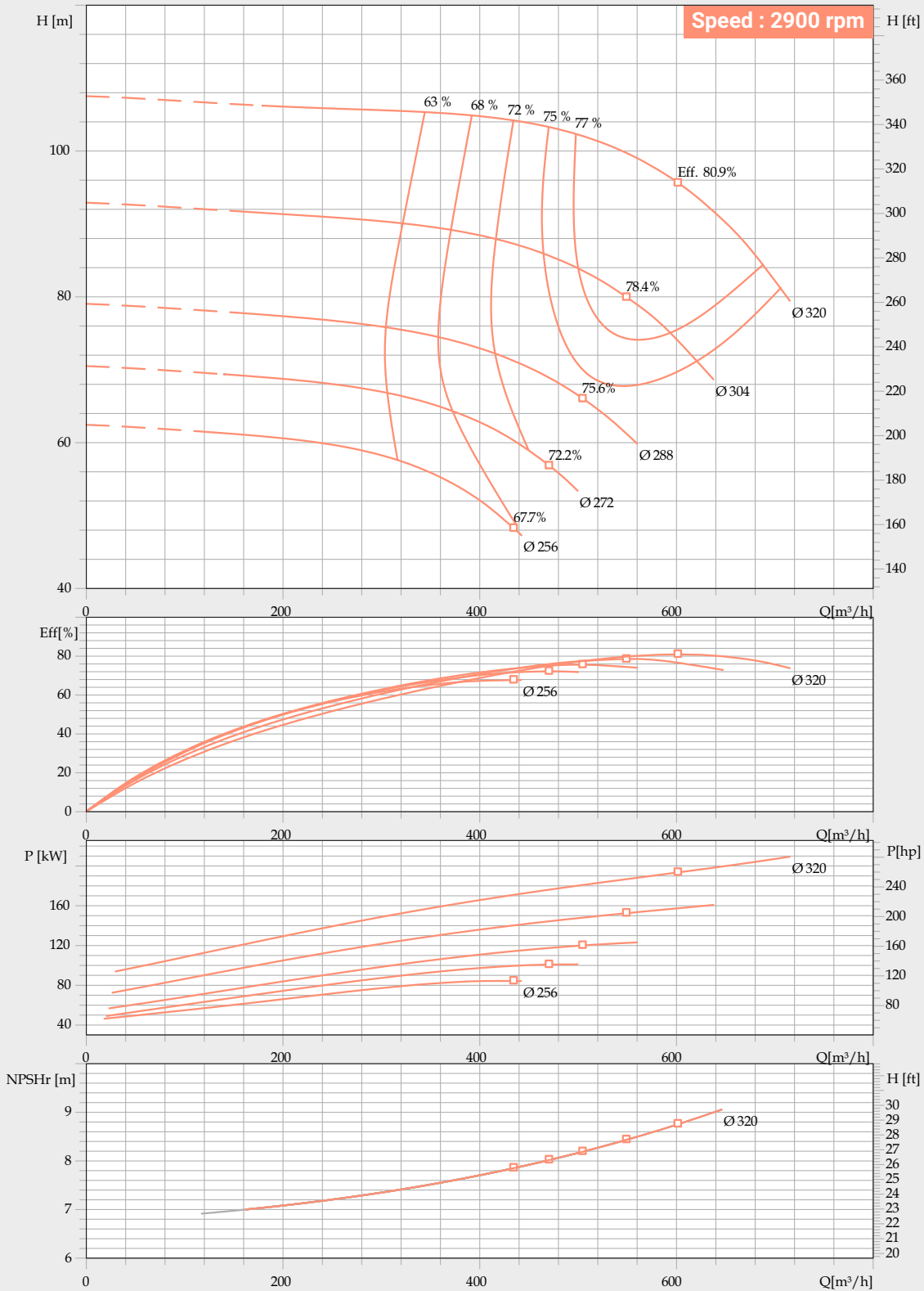

Performance to tolerance as per ISO 9906 Grade 2B.
 For safety kindly consider a margin of 0.5m higher of NPSH.
 In view of continuous development, the informations / descriptions / specification / illustration are subjected to change without notice.

PERFORMANCE CURVE

Pump Model : FSCW-150/340

Pump Size in mm : 200 x 150 x 340

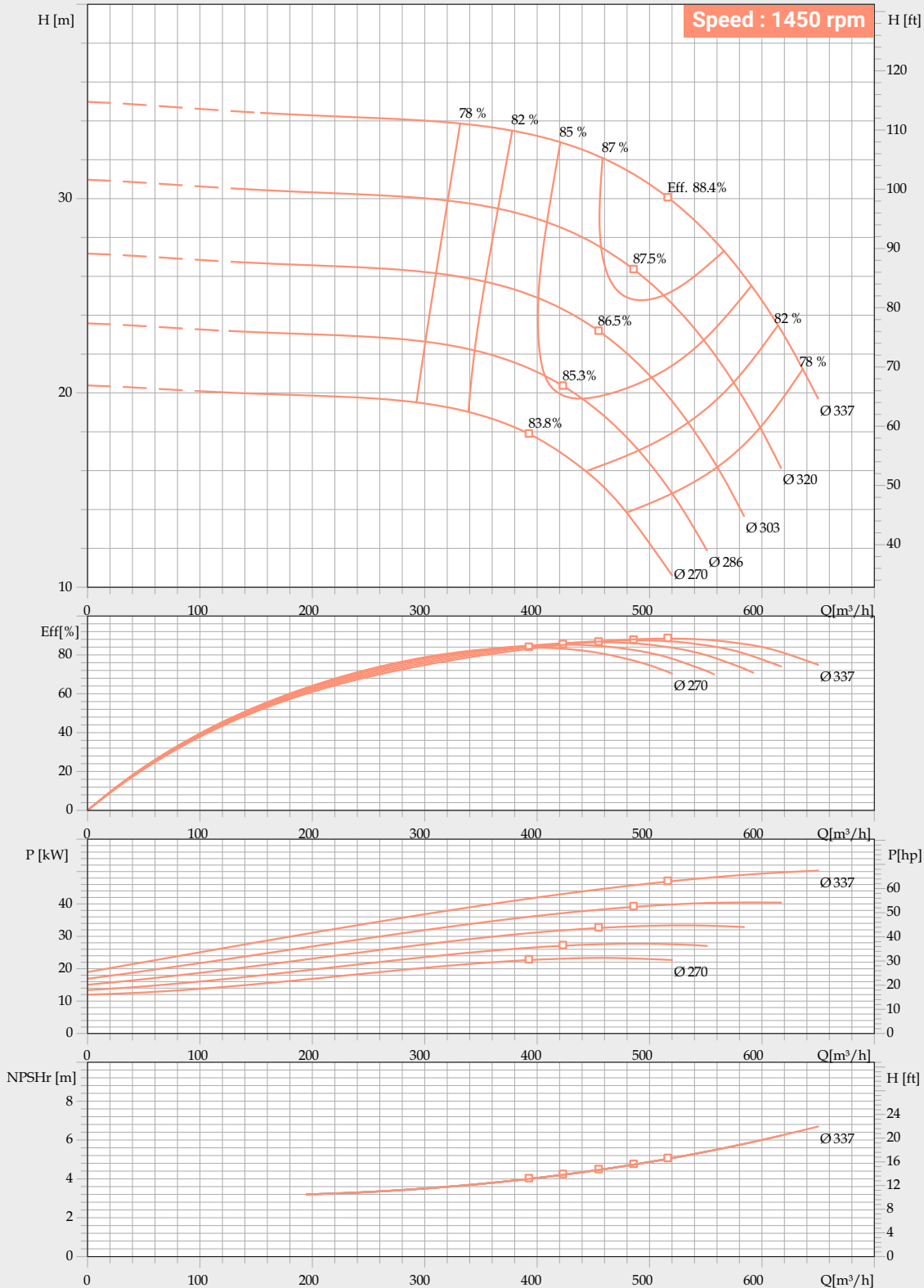

Performance to tolerance as per ISO 9906 Grade 2B.
 For safety kindly consider a margin of 0.5m higher of NPSH.
 In view of continuous development, the informations / descriptions / specification / illustration are subjected to change without notice.

PERFORMANCE CURVE

Pump Model : **FSCW-150/380**

Pump Size in mm : **200 x 150 x 380**

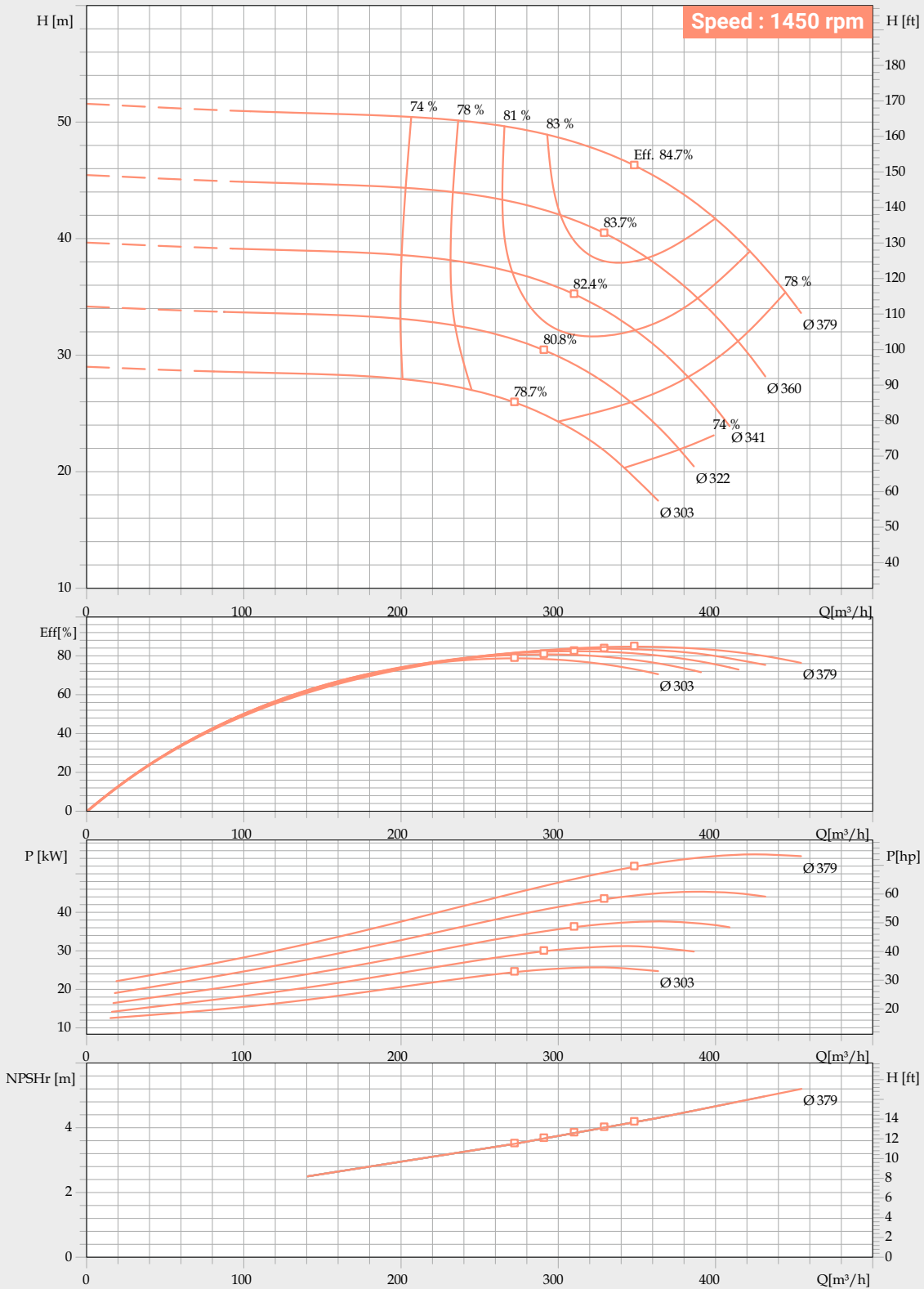

Performance to tolerance as per ISO 9906 Grade 2B.
 For safety kindly consider a margin of 0.5m higher of NPSH.
 In view of continuous development, the informations / descriptions / specification / illustration are subjected to change without notice.

PERFORMANCE CURVE

Pump Model : FSCW-150/430

Pump Size in mm : 200 x 150 x 430

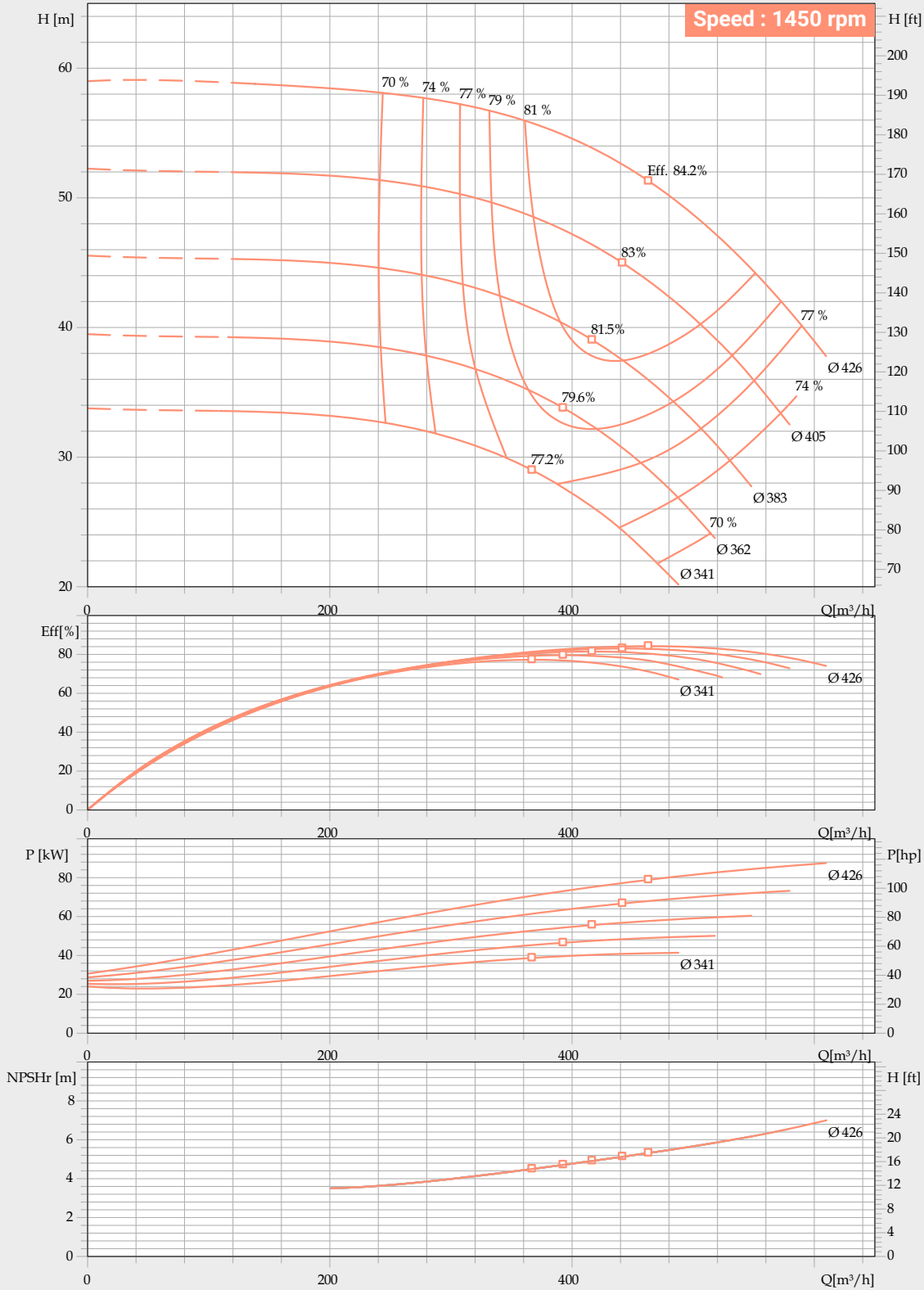

Performance to tolerance as per ISO 9906 Grade 2B.
 For safety kindly consider a margin of 0.5m higher of NPSH.
 In view of continuous development, the informations / descriptions / specification / illustration are subjected to change without notice.

PERFORMANCE CURVE

Pump Model : FSCW-150/450

Pump Size in mm : 200 x 150 x 450

Speed : 1450 rpm

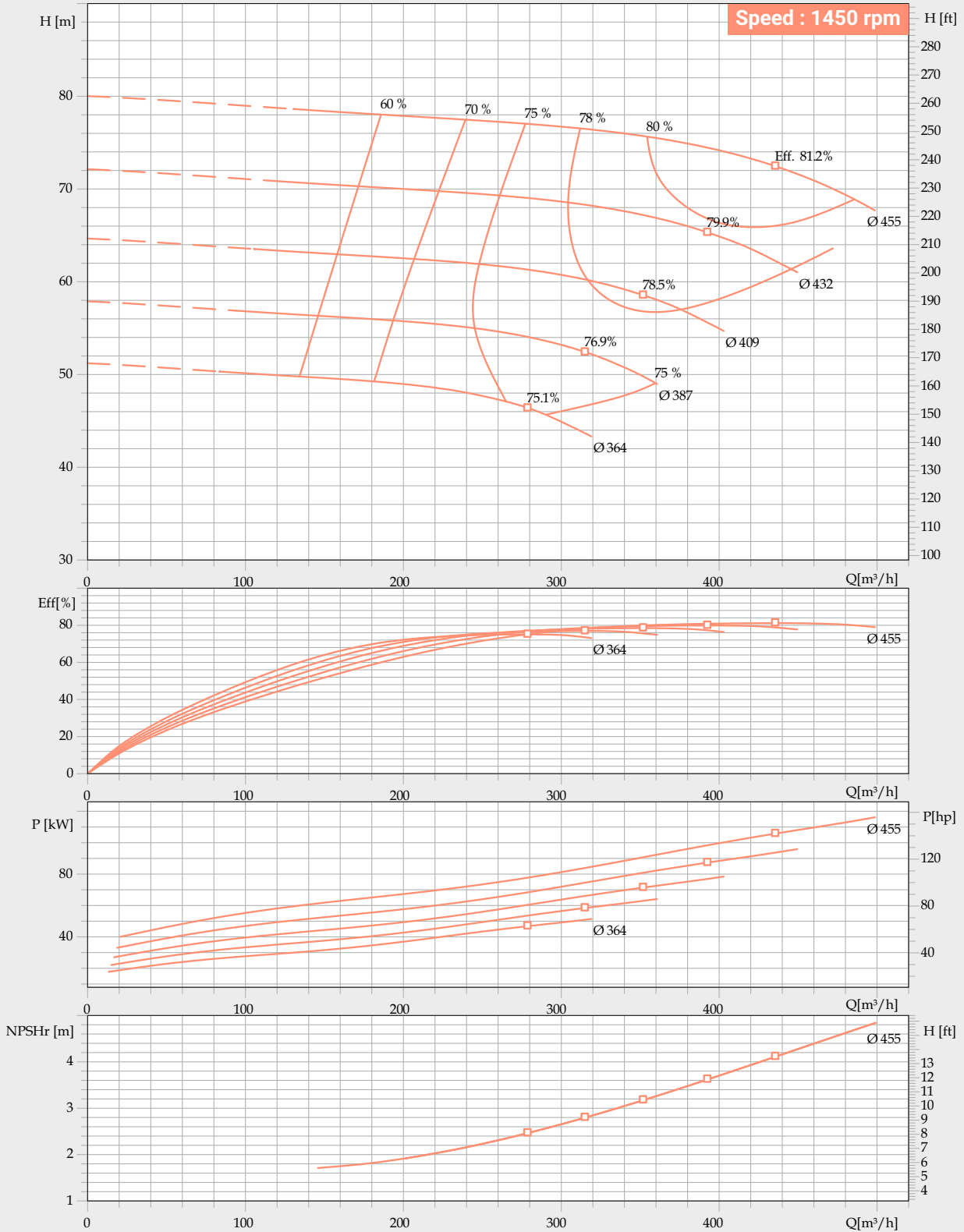

Performance to tolerance as per ISO 9906 Grade 2B.

For safety kindly consider a margin of 0.5m higher of NPSH.

In view of continuous development, the informations / descriptions / specification / illustration are subjected to change without notice.

PERFORMANCE CURVE

Pump Model : FSCW-150/530

Pump Size in mm : 200 x 150 x 530

Speed : 1450 rpm

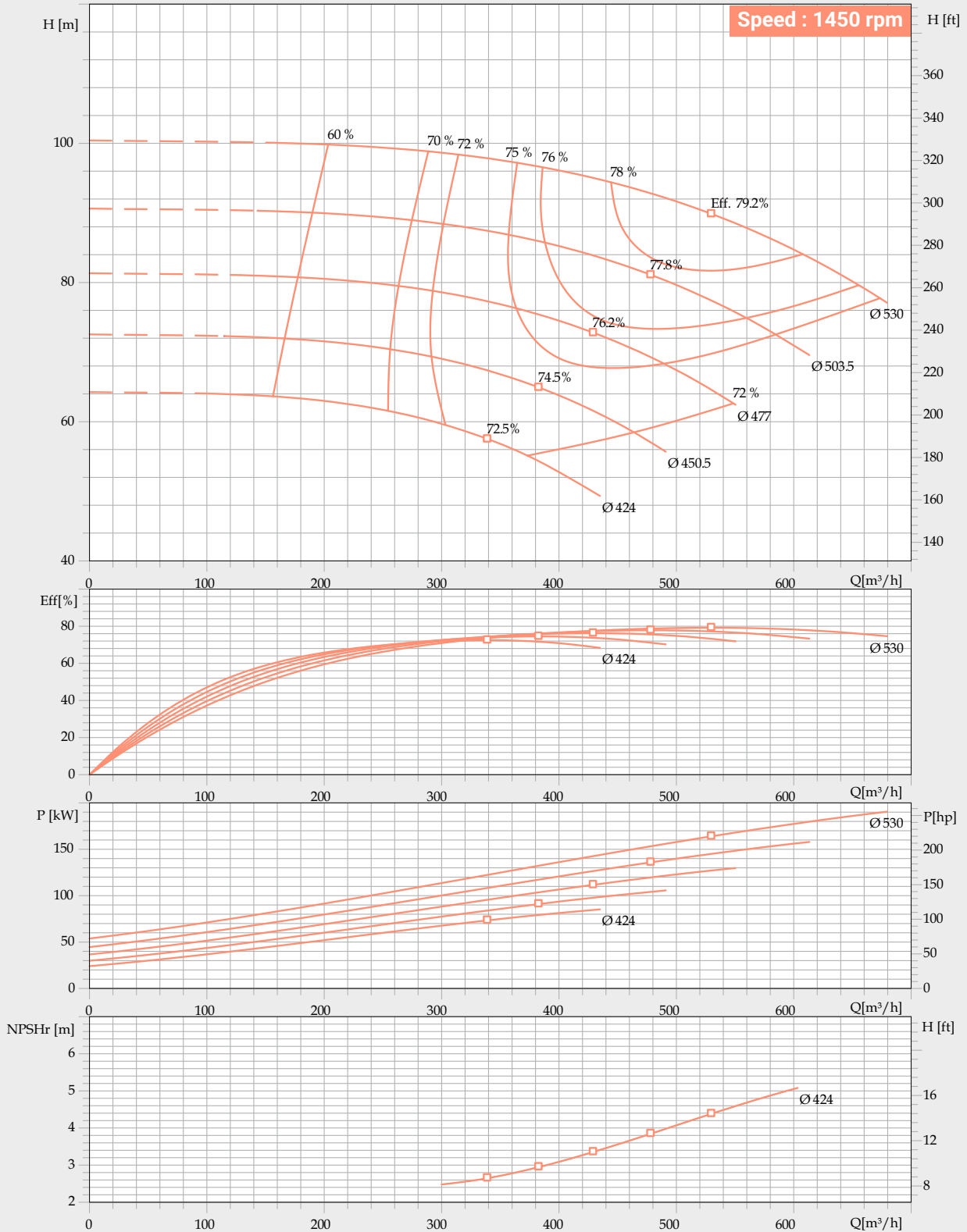

Performance to tolerance as per ISO 9906 Grade 2B.
 For safety kindly consider a margin of 0.5m higher of NPSH.
 In view of continuous development, the informations / descriptions / specification / illustration are subjected to change without notice.

PERFORMANCE CURVE

Pump Model : **FSCW-200/320**

Pump Size in mm : **200 x 200 x 320**

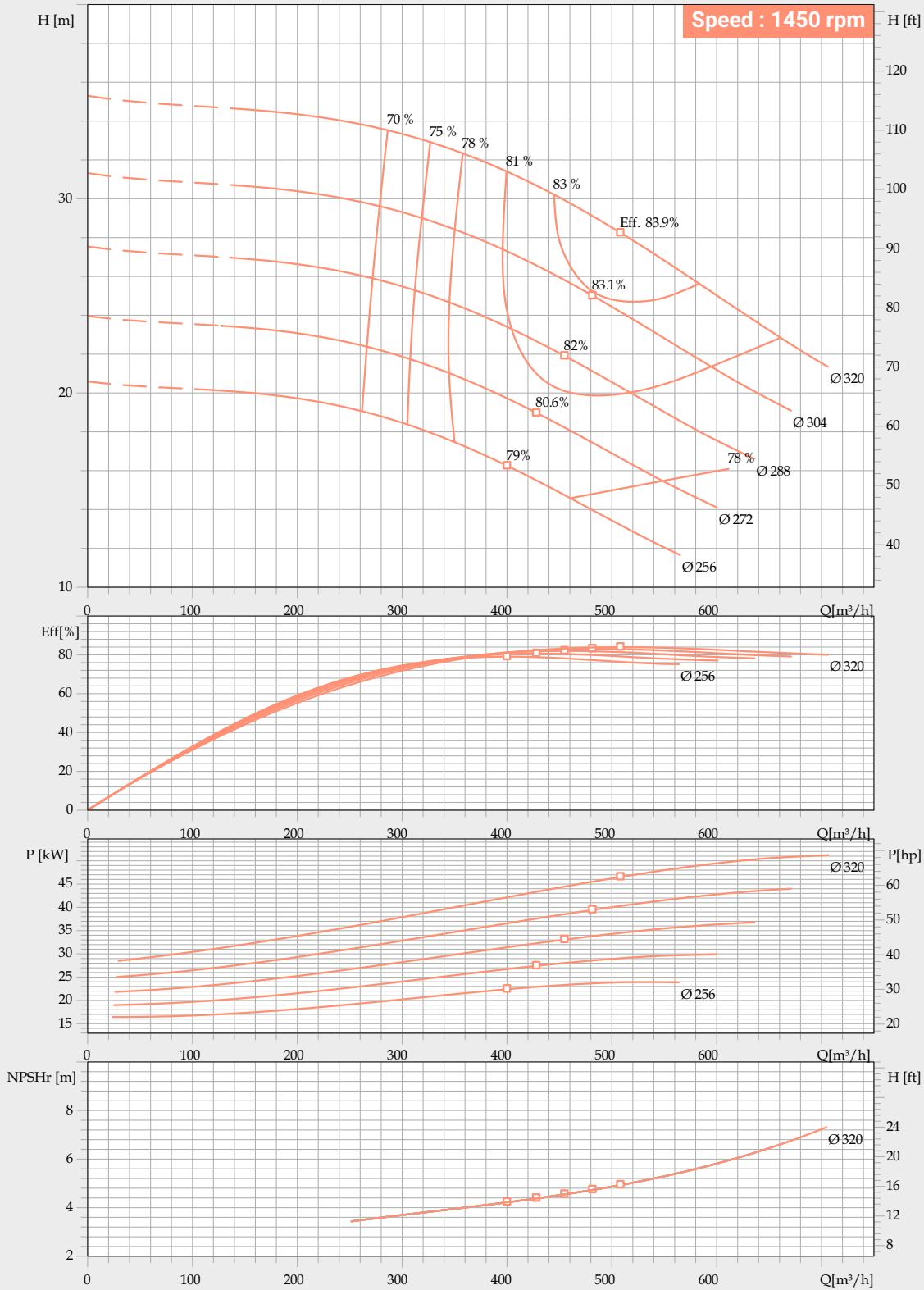

Performance to tolerance as per ISO 9906 Grade 2B.

For safety kindly consider a margin of 0.5m higher of NPSH.

In view of continuous development, the informations / descriptions / specification / illustration are subjected to change without notice.

PERFORMANCE CURVE

Pump Model : **FSCW-200/340**

Pump Size in mm : **200 x 200 x 340**

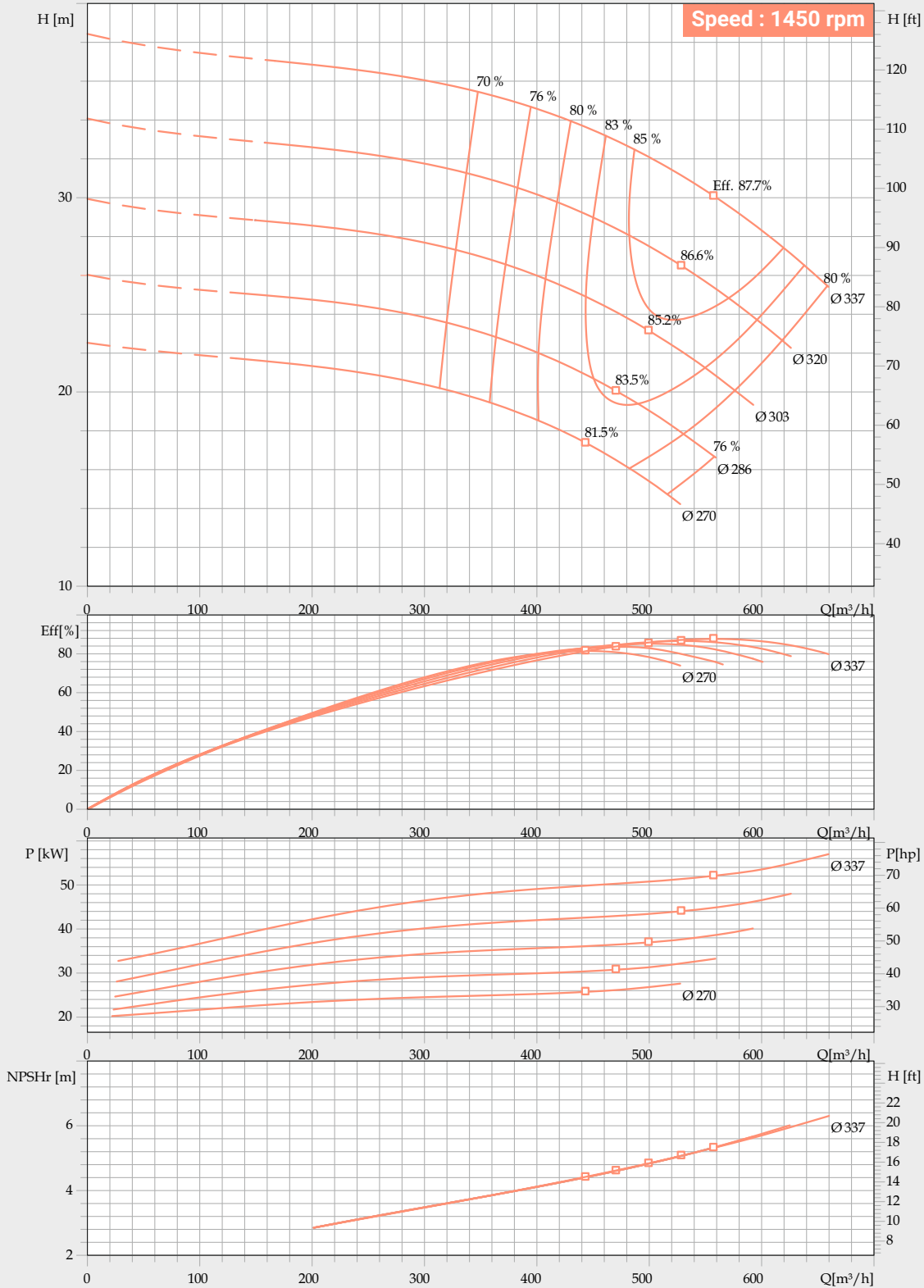

Performance to tolerance as per ISO 9906 Grade 2B.

For safety kindly consider a margin of 0.5m higher of NPSH.

In view of continuous development, the informations / descriptions / specification / illustration are subjected to change without notice.

PERFORMANCE CURVE

Pump Model : **FSCW-200/380**

Pump Size in mm : **200 x 200 x 380**

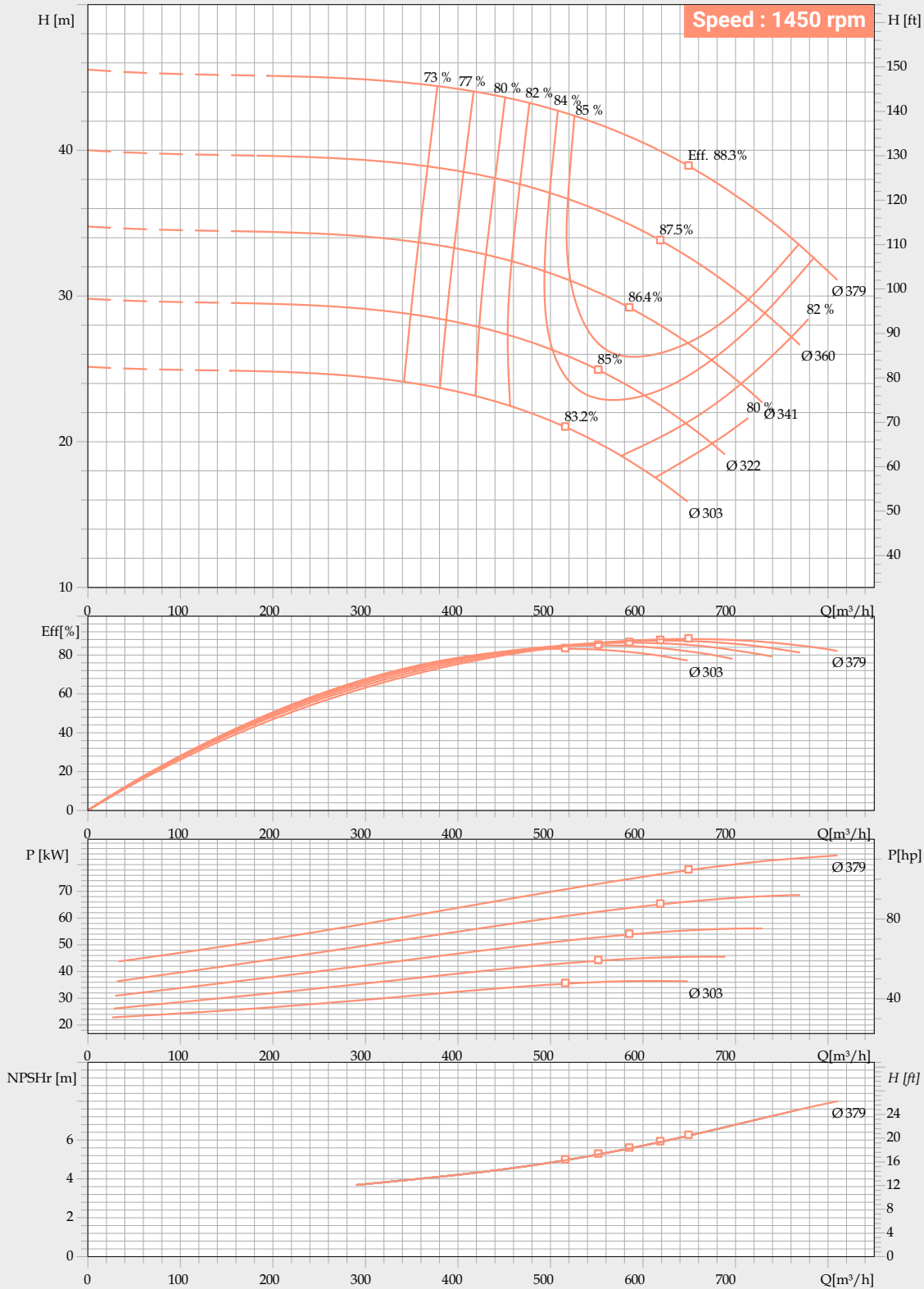

Performance to tolerance as per ISO 9906 Grade 2B.

For safety kindly consider a margin of 0.5m higher of NPSH.

In view of continuous development, the informations / descriptions / specification / illustration are subjected to change without notice.

PERFORMANCE CURVE

Pump Model : FSCW-200/430

Pump Size in mm : 200 x 200 x 430

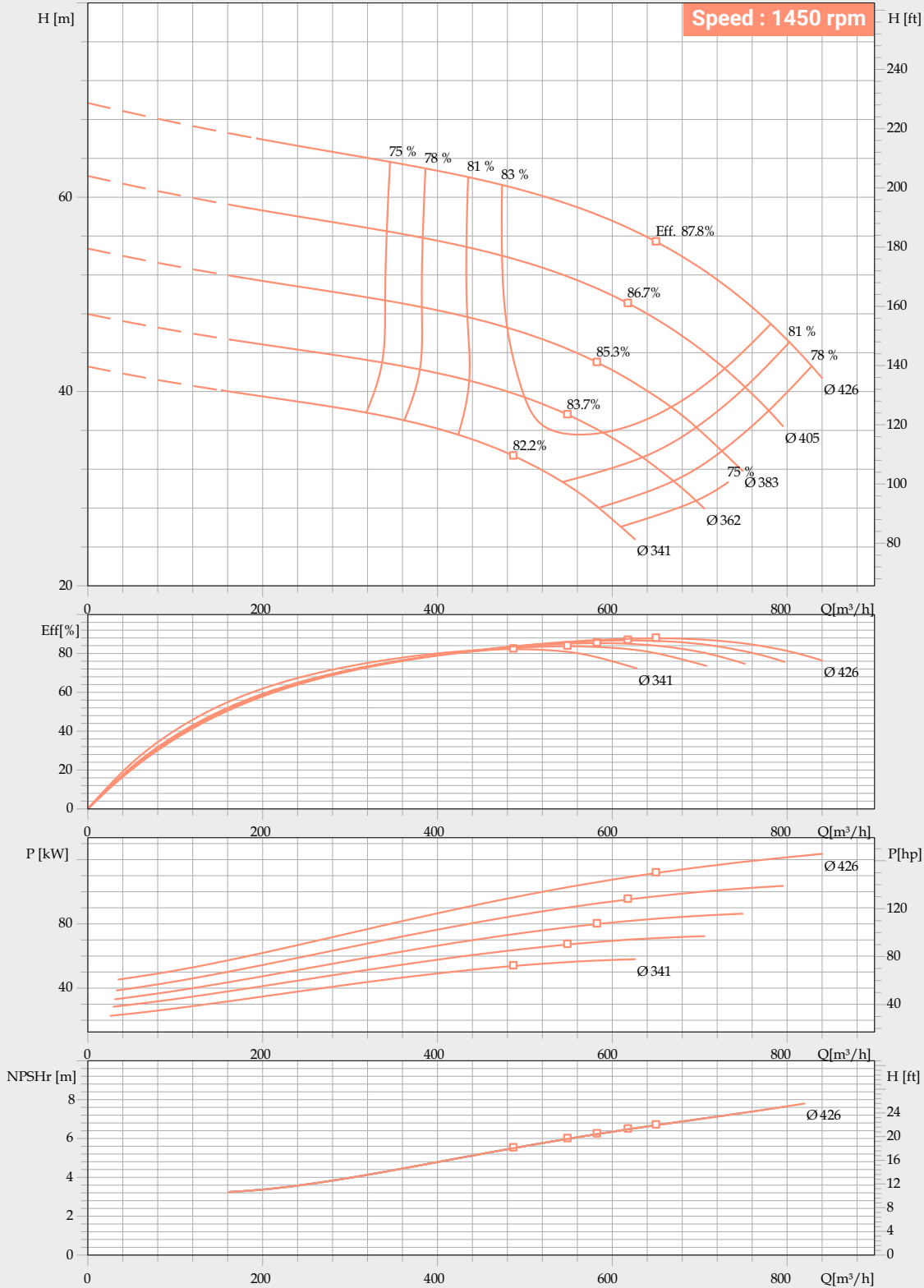

Performance to tolerance as per ISO 9906 Grade 2B.

For safety kindly consider a margin of 0.5m higher of NPSH.

In view of continuous development, the informations / descriptions / specification / illustration are subjected to change without notice.

PERFORMANCE CURVE

Pump Model : **FSCW-200/460**

Pump Size in mm : **200 x 200 x 460**

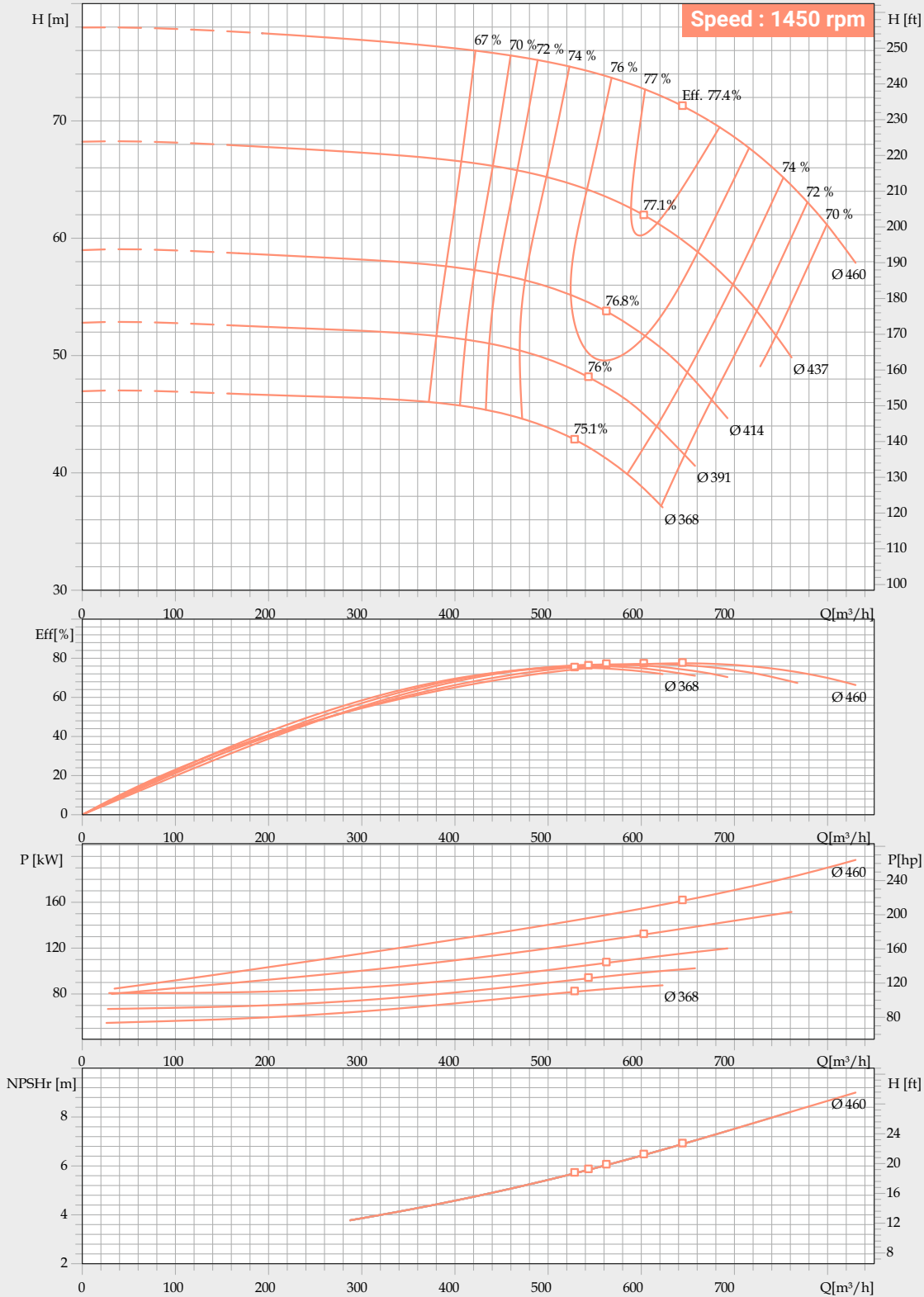

Performance to tolerance as per ISO 9906 Grade 2B.
 For safety kindly consider a margin of 0.5m higher of NPSH.
 In view of continuous development, the informations / descriptions / specification / illustration are subjected to change without notice.

PERFORMANCE CURVE

Pump Model : **FSCW-200/510**

Pump Size in mm : **200 x 200 x 510**

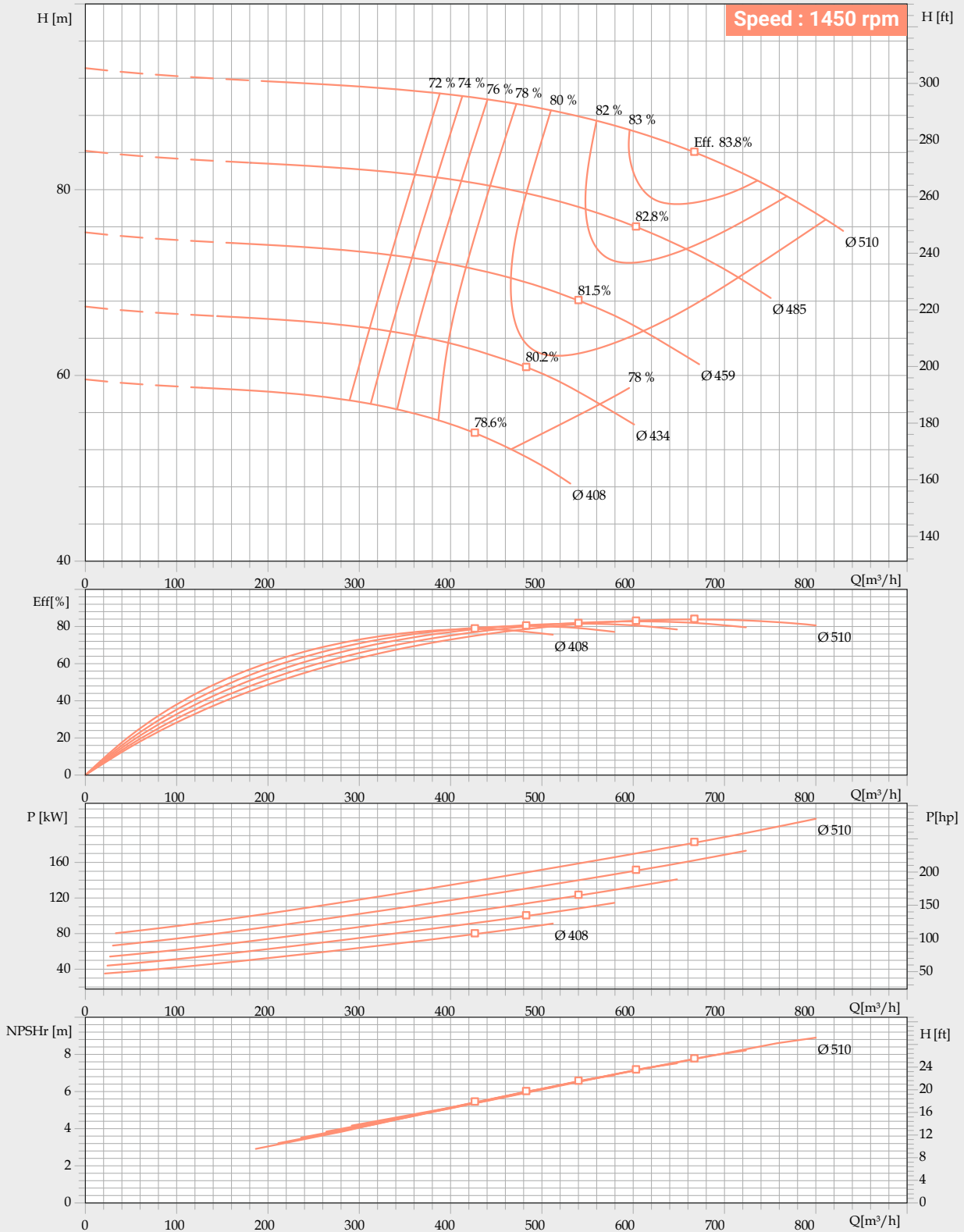

Performance to tolerance as per ISO 9906 Grade 2B.
 For safety kindly consider a margin of 0.5m higher of NPSH.
 In view of continuous development, the informations / descriptions / specification / illustration are subjected to change without notice.

PERFORMANCE CURVE

Pump Model : **FSCW-200/540**

Pump Size in mm : **200 x 200 x 540**

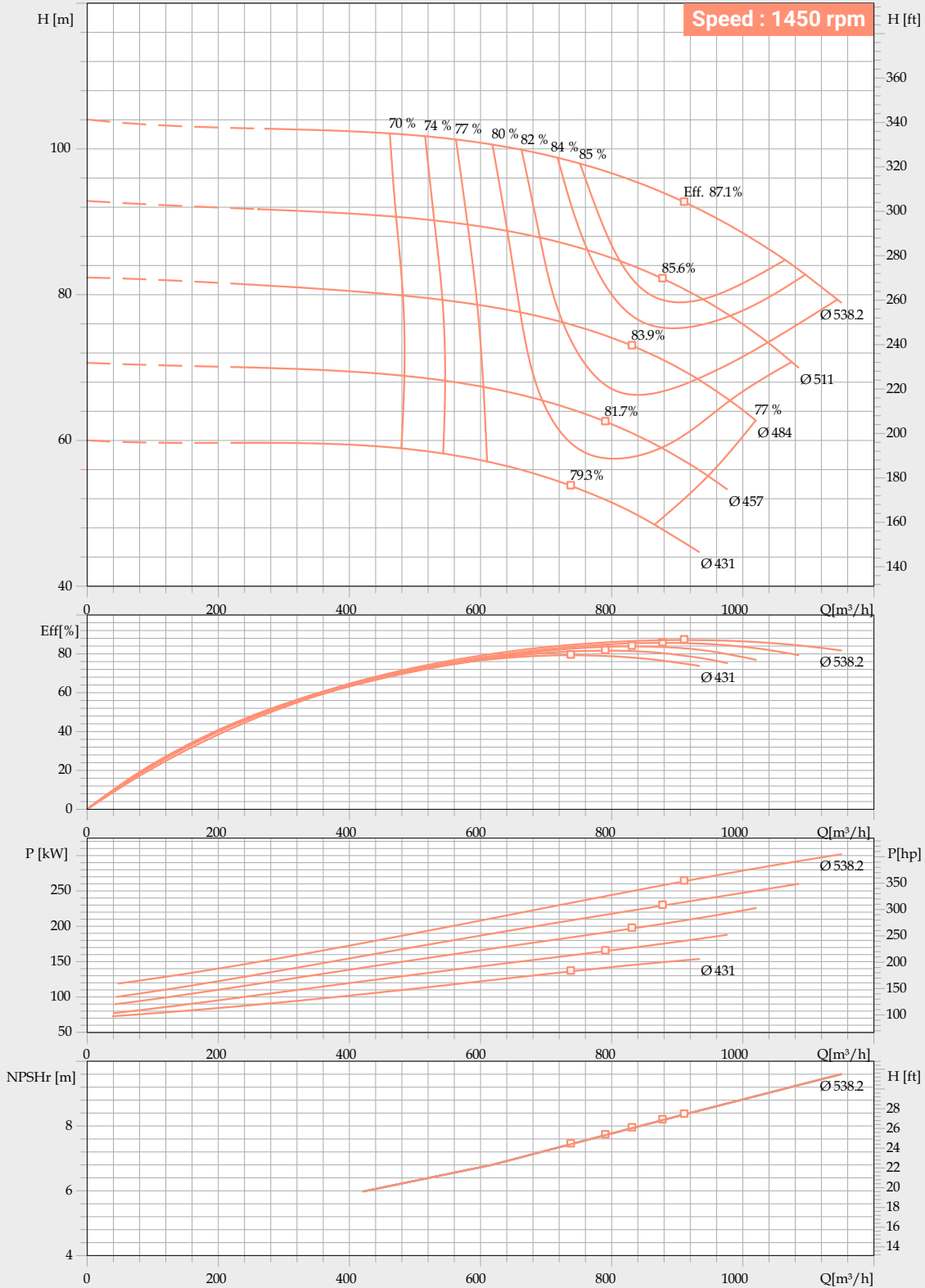

Performance to tolerance as per ISO 9906 Grade 2B.
 For safety kindly consider a margin of 0.5m higher of NPSH.
 In view of continuous development, the informations / descriptions / specification / illustration are subjected to change without notice.

PERFORMANCE CURVE

Pump Model : **FSCW-200/570**

Pump Size in mm : **200 x 200 x 570**

Speed : 1450 rpm

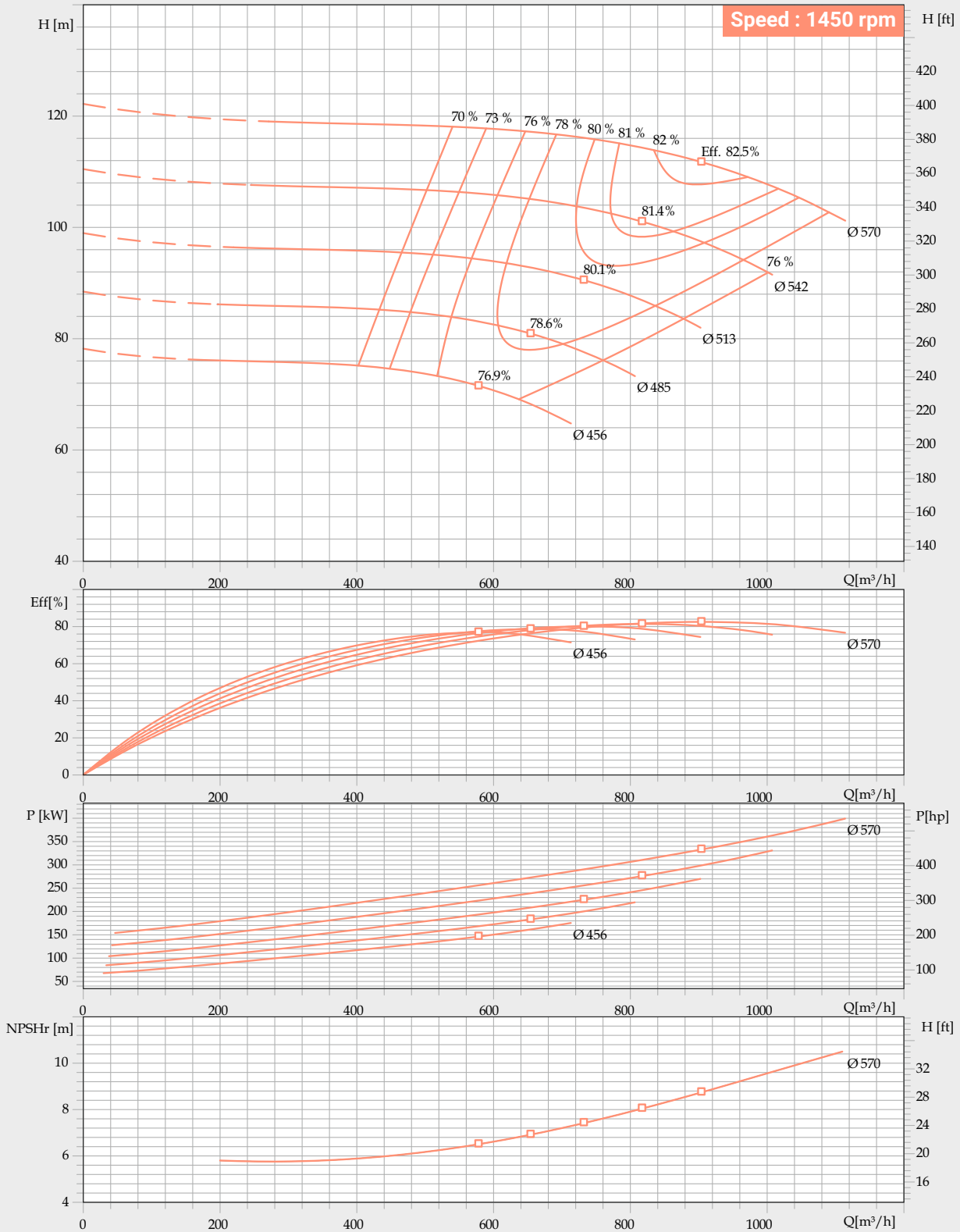

Performance to tolerance as per ISO 9906 Grade 2B.

For safety kindly consider a margin of 0.5m higher of NPSH.

In view of continuous development, the informations / descriptions / specification / illustration are subjected to change without notice.

PERFORMANCE CURVE

Pump Model : FSCW-250/330

Pump Size in mm : 250 x 250 x 330

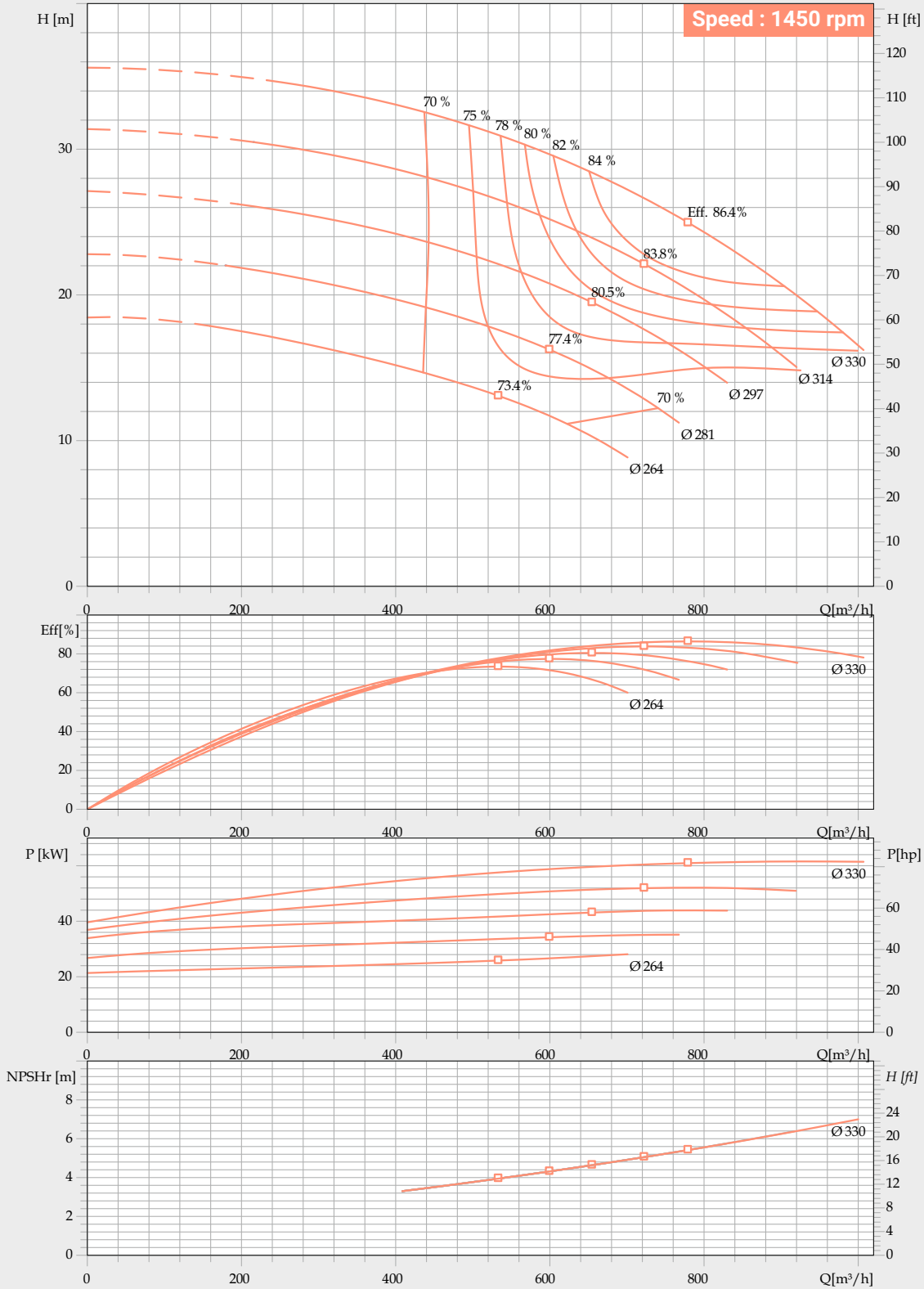

Performance to tolerance as per ISO 9906 Grade 2B.

For safety kindly consider a margin of 0.5m higher of NPSH.

In view of continuous development, the informations / descriptions / specification / illustration are subjected to change without notice.

PERFORMANCE CURVE

Pump Model : FSCW-250/360

Pump Size in mm : 250 x 250 x 360

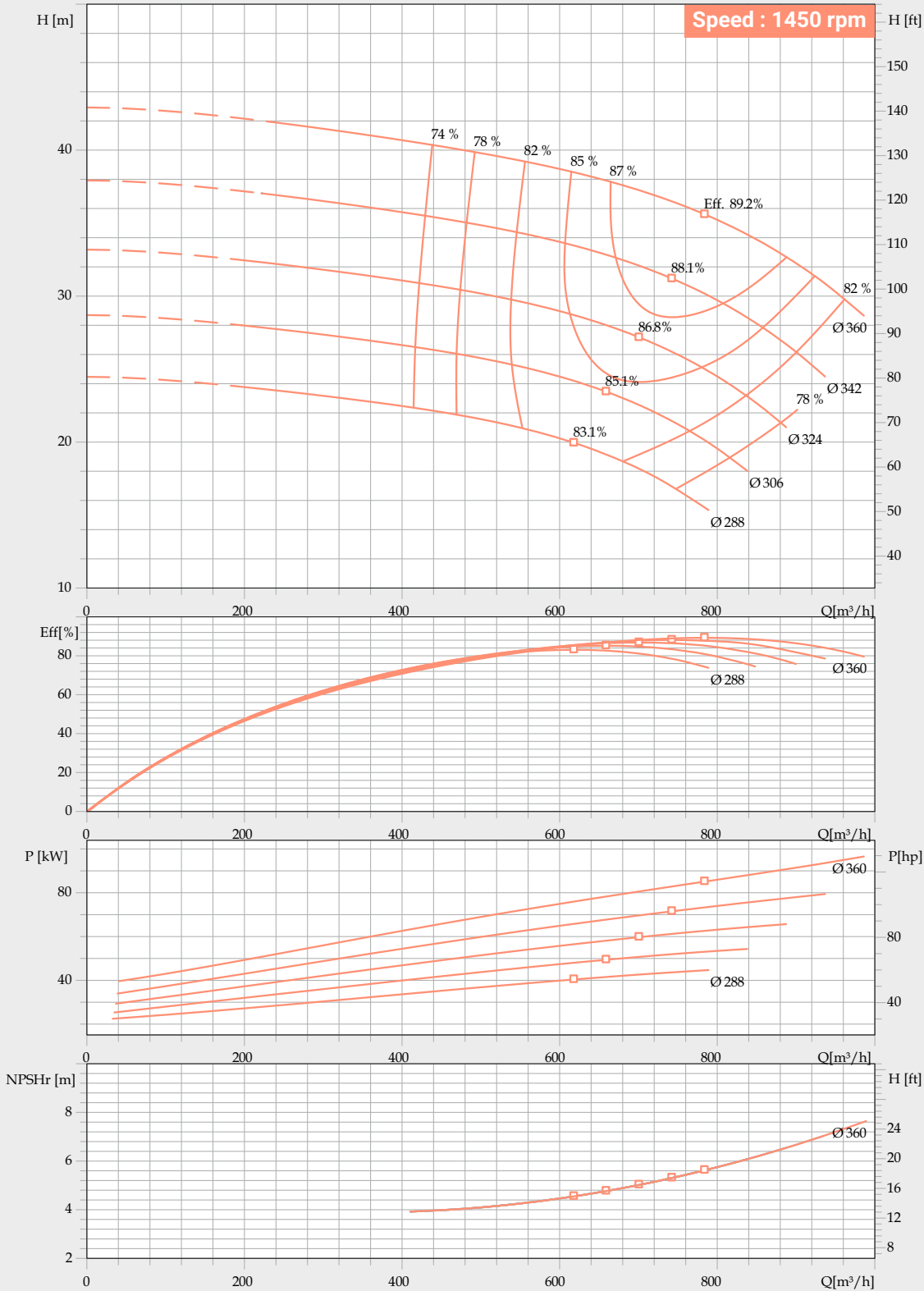

Performance to tolerance as per ISO 9906 Grade 2B.

For safety kindly consider a margin of 0.5m higher of NPSH.

In view of continuous development, the informations / descriptions / specification / illustration are subjected to change without notice.

PERFORMANCE CURVE

Pump Model : FSCW-250/380

Pump Size in mm : 250 x 250 x 380

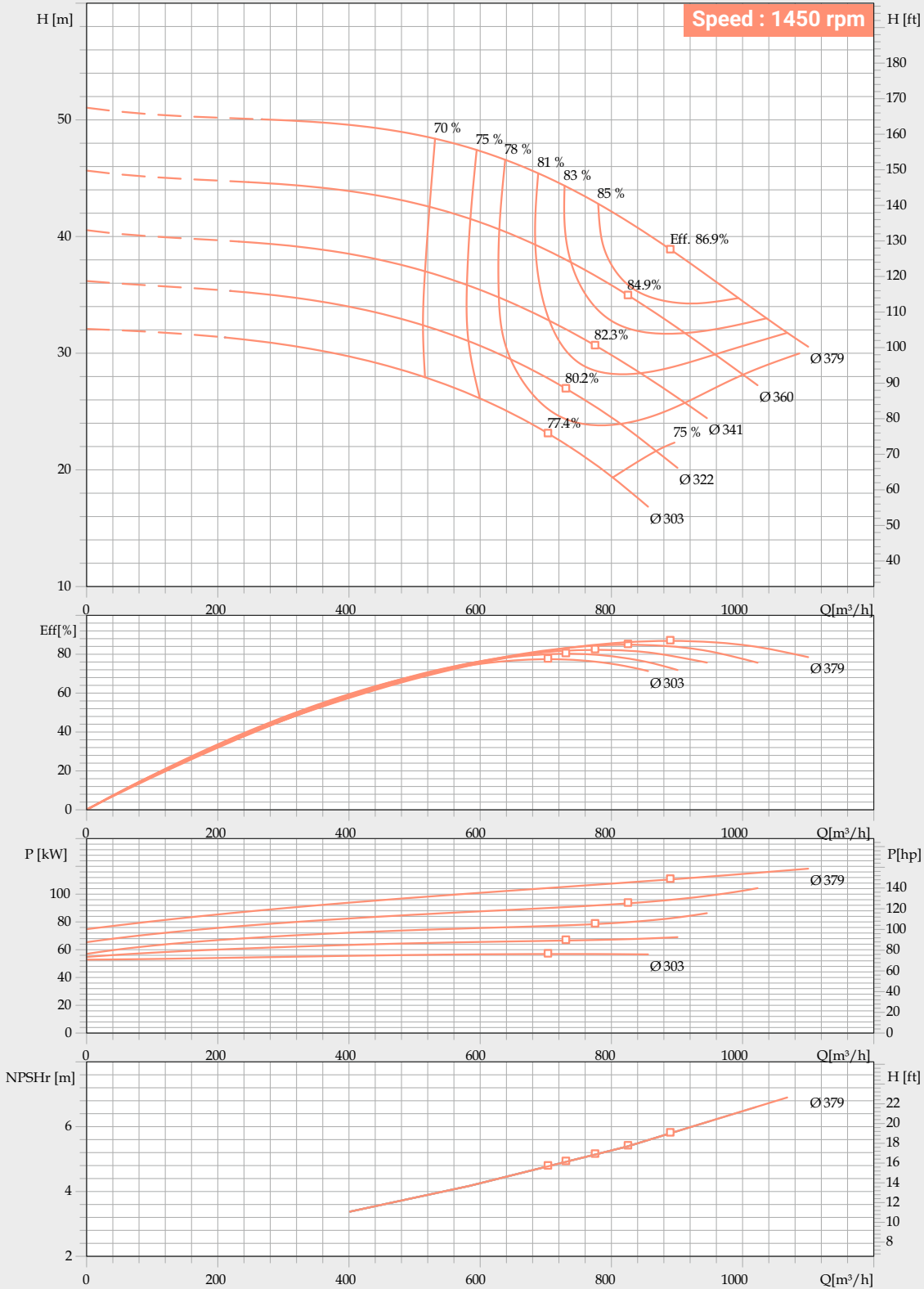

Performance to tolerance as per ISO 9906 Grade 2B.
 For safety kindly consider a margin of 0.5m higher of NPSH.
 In view of continuous development, the informations / descriptions / specification / illustration are subjected to change without notice.

PERFORMANCE CURVE

Pump Model : FSCW-250/400

Pump Size in mm : 300 x 250 x 400

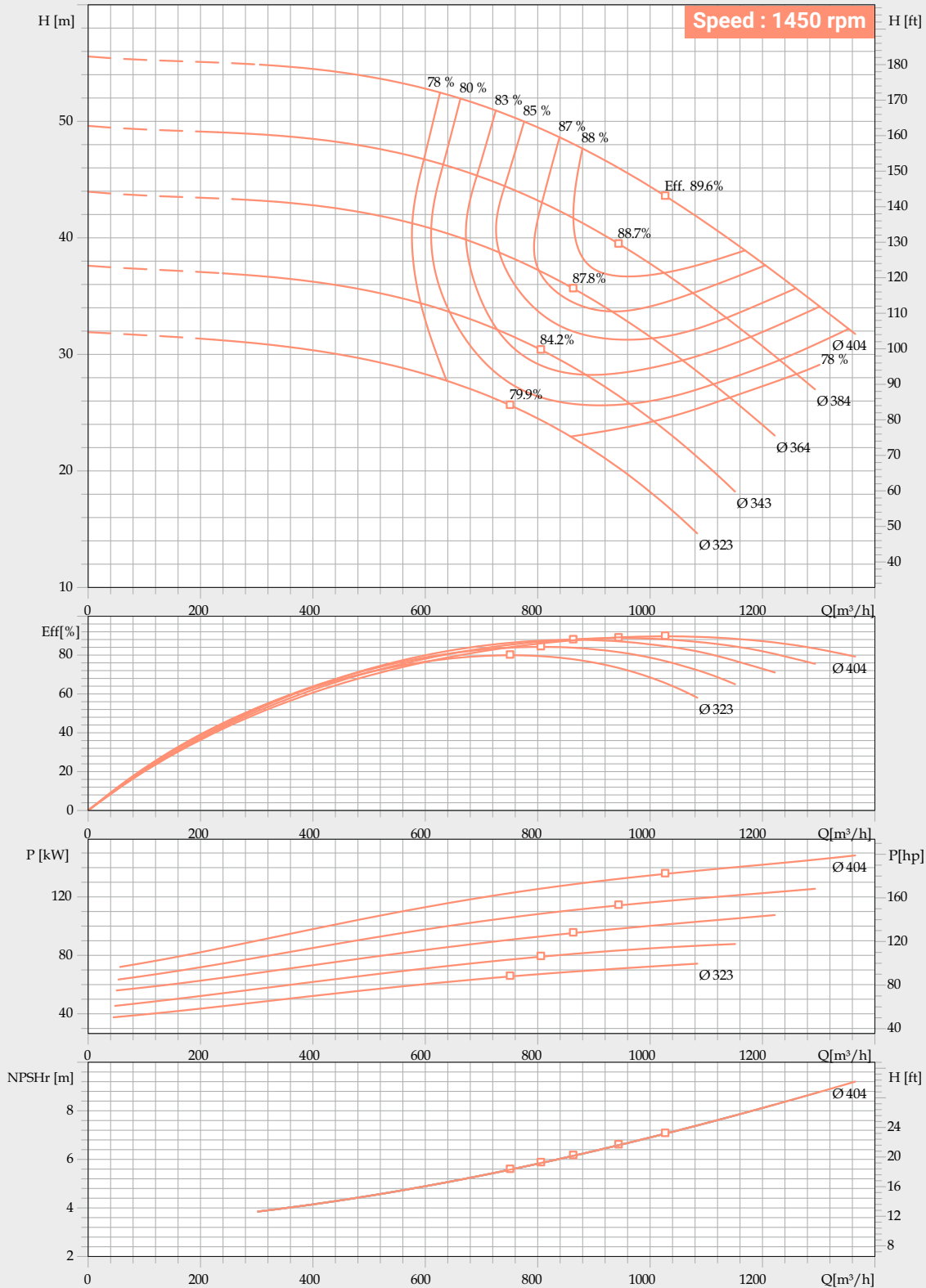

Performance to tolerance as per ISO 9906 Grade 2B.
 For safety kindly consider a margin of 0.5m higher of NPSH.
 In view of continuous development, the informations / descriptions / specification / illustration are subjected to change without notice.

PERFORMANCE CURVE

Pump Model : FSCW-250/425

Pump Size in mm : 250 x 250 x 425

Speed : 1450 rpm

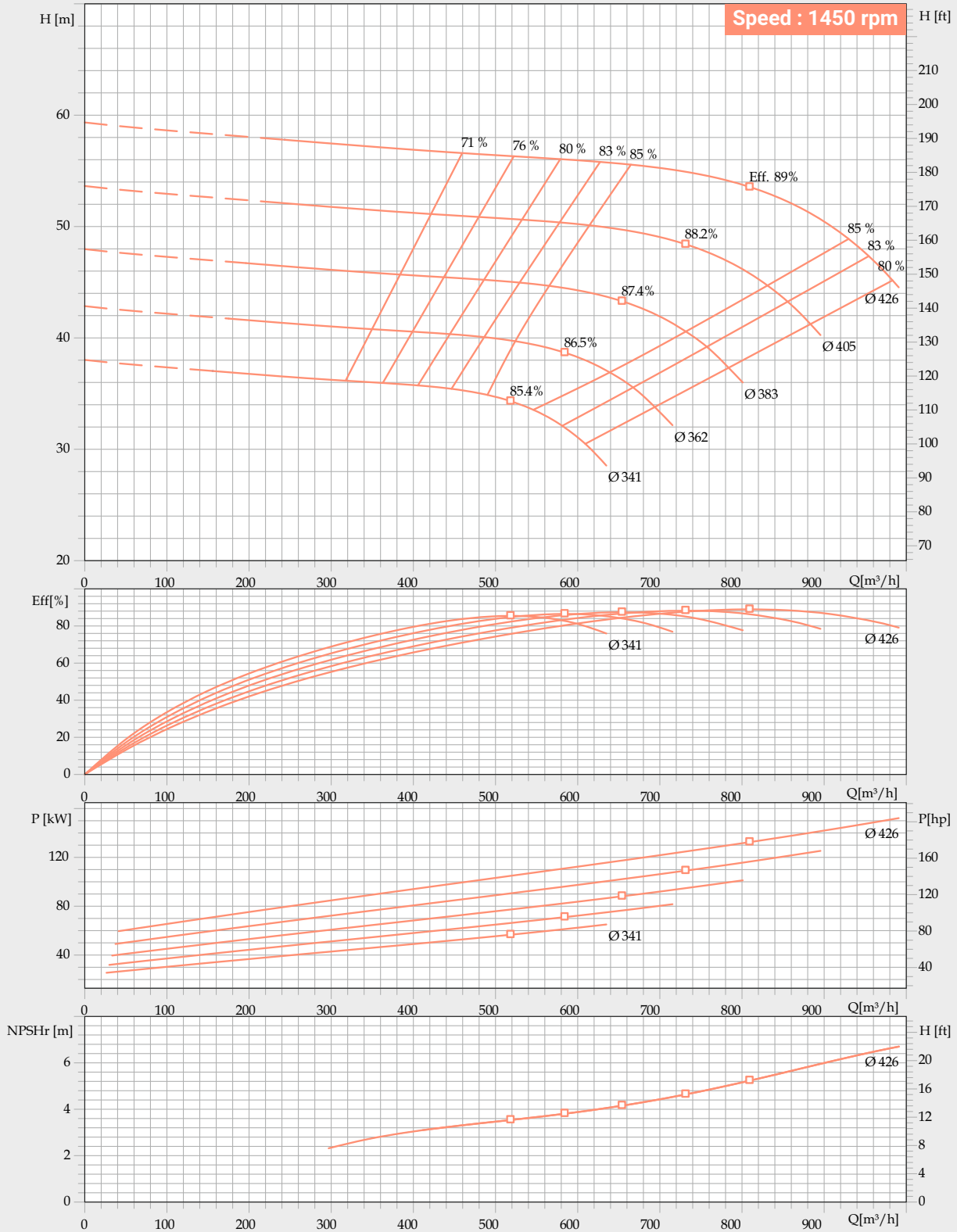

Performance to tolerance as per ISO 9906 Grade 2B.
 For safety kindly consider a margin of 0.5m higher of NPSH.
 In view of continuous development, the informations / descriptions / specification / illustration are subjected to change without notice.

PERFORMANCE CURVE

Pump Model : FSCW-250/430

Pump Size in mm : 300 x 250 x 430

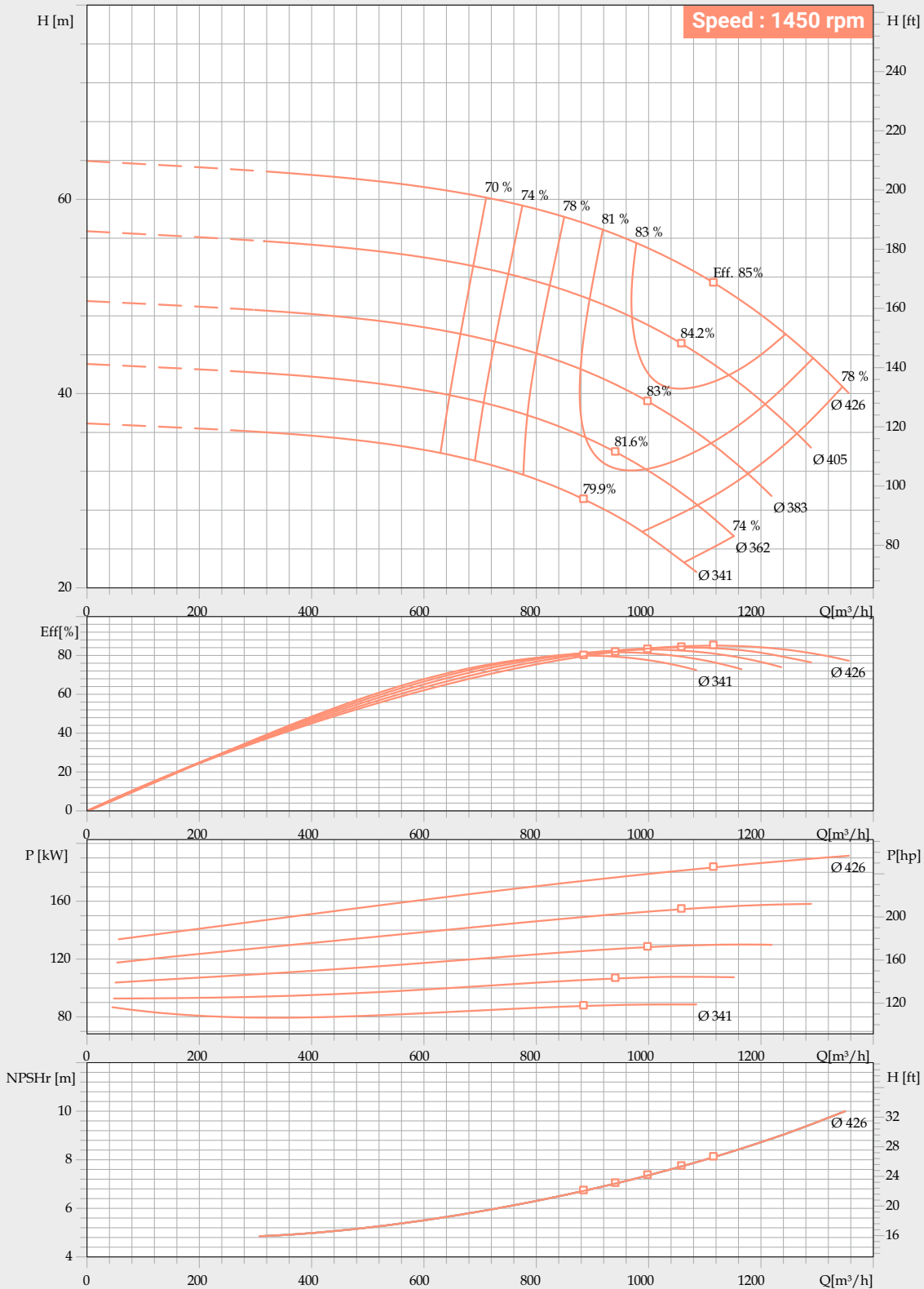

Performance to tolerance as per ISO 9906 Grade 2B.

For safety kindly consider a margin of 0.5m higher of NPSH.

In view of continuous development, the informations / descriptions / specification / illustration are subjected to change without notice.

PERFORMANCE CURVE

Pump Model : FSCW-250/475

Pump Size in mm : 300 x 250 x 475

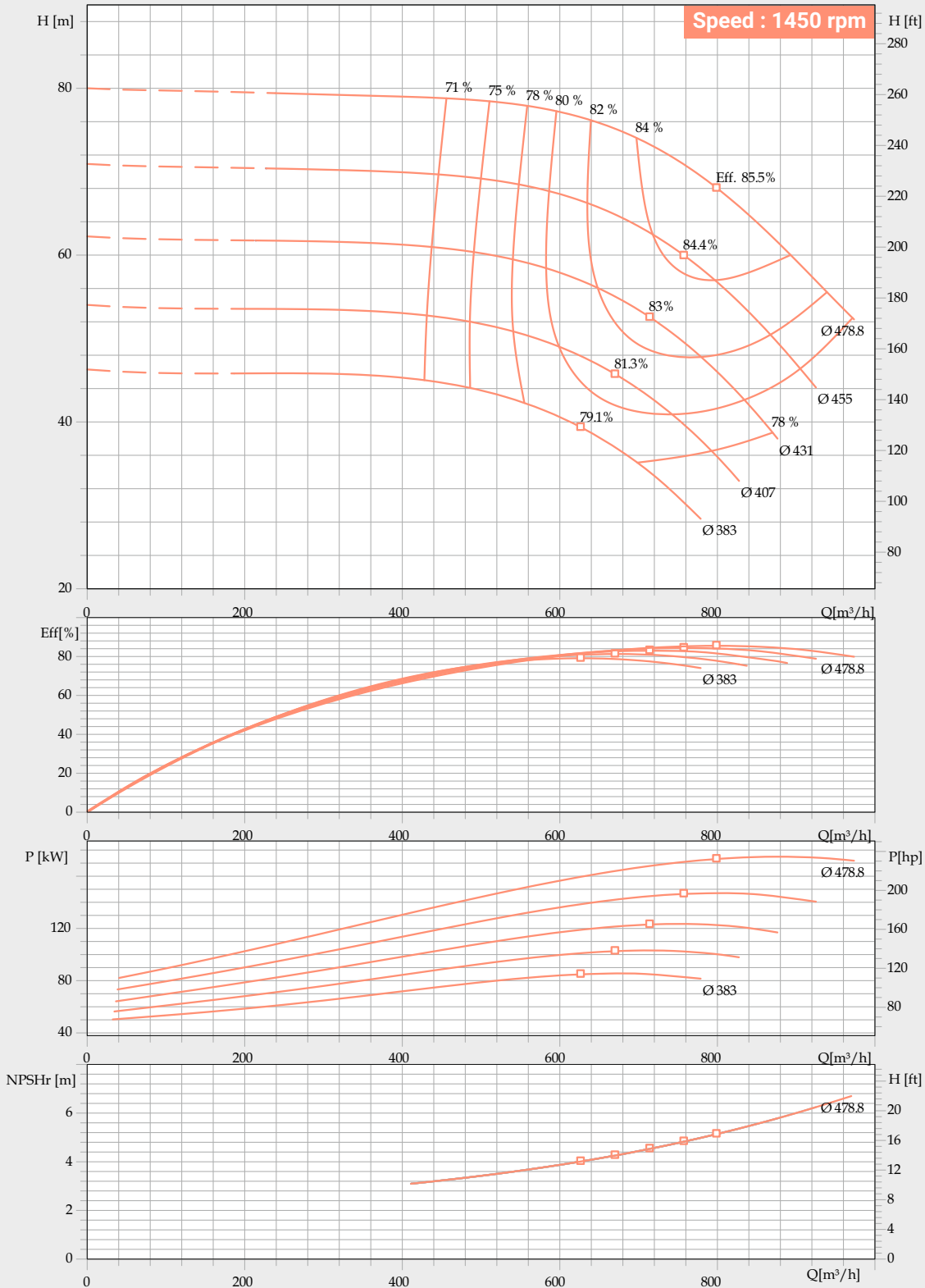

Performance to tolerance as per ISO 9906 Grade 2B.

For safety kindly consider a margin of 0.5m higher of NPSH.

In view of continuous development, the informations / descriptions / specification / illustration are subjected to change without notice.

PERFORMANCE CURVE

Pump Model : FSCW-250/480

Pump Size in mm : 300 x 250 x 480

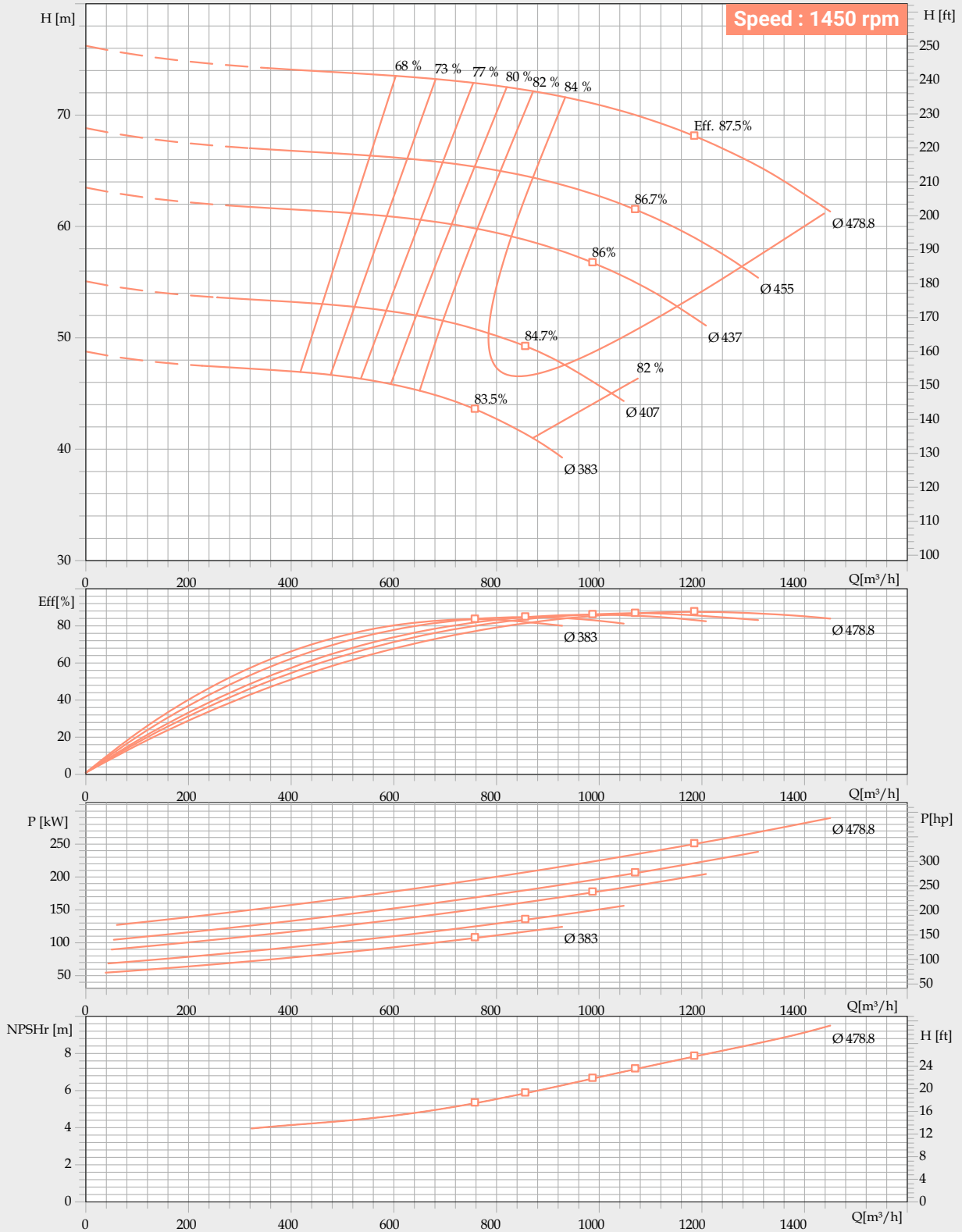

Performance to tolerance as per ISO 9906 Grade 2B.

For safety kindly consider a margin of 0.5m higher of NPSH.

In view of continuous development, the informations / descriptions / specification / illustration are subjected to change without notice.

PERFORMANCE CURVE

Pump Model : FSCW-250/540

Pump Size in mm : 300 x 250 x 540

Speed : 1450 rpm

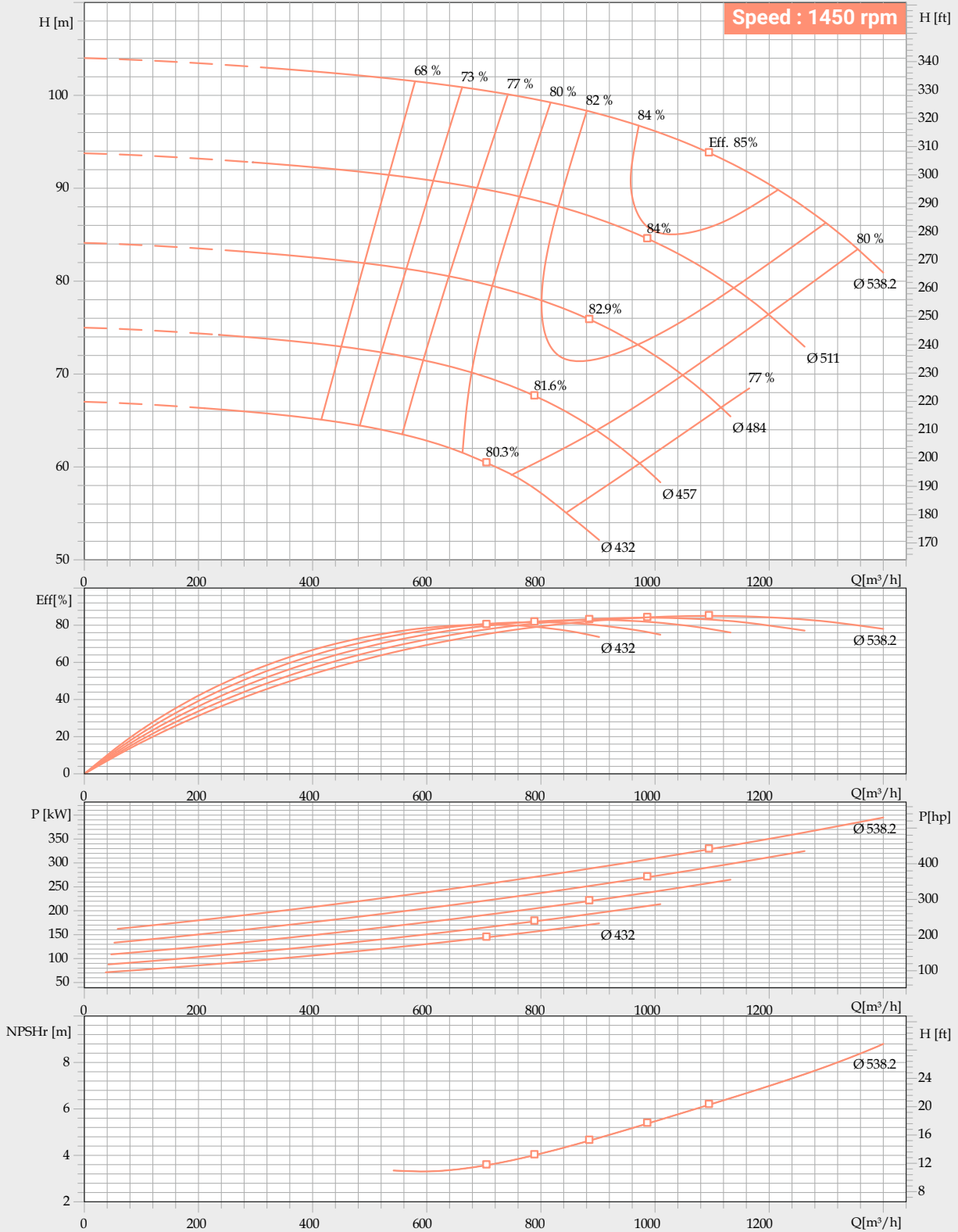

Performance to tolerance as per ISO 9906 Grade 2B.
 For safety kindly consider a margin of 0.5m higher of NPSH.
 In view of continuous development, the informations / descriptions / specification / illustration are subjected to change without notice.

PERFORMANCE CURVE

Pump Model : FSCW-250/590

Pump Size in mm : 300 x 250 x 590

Speed : 1450 rpm

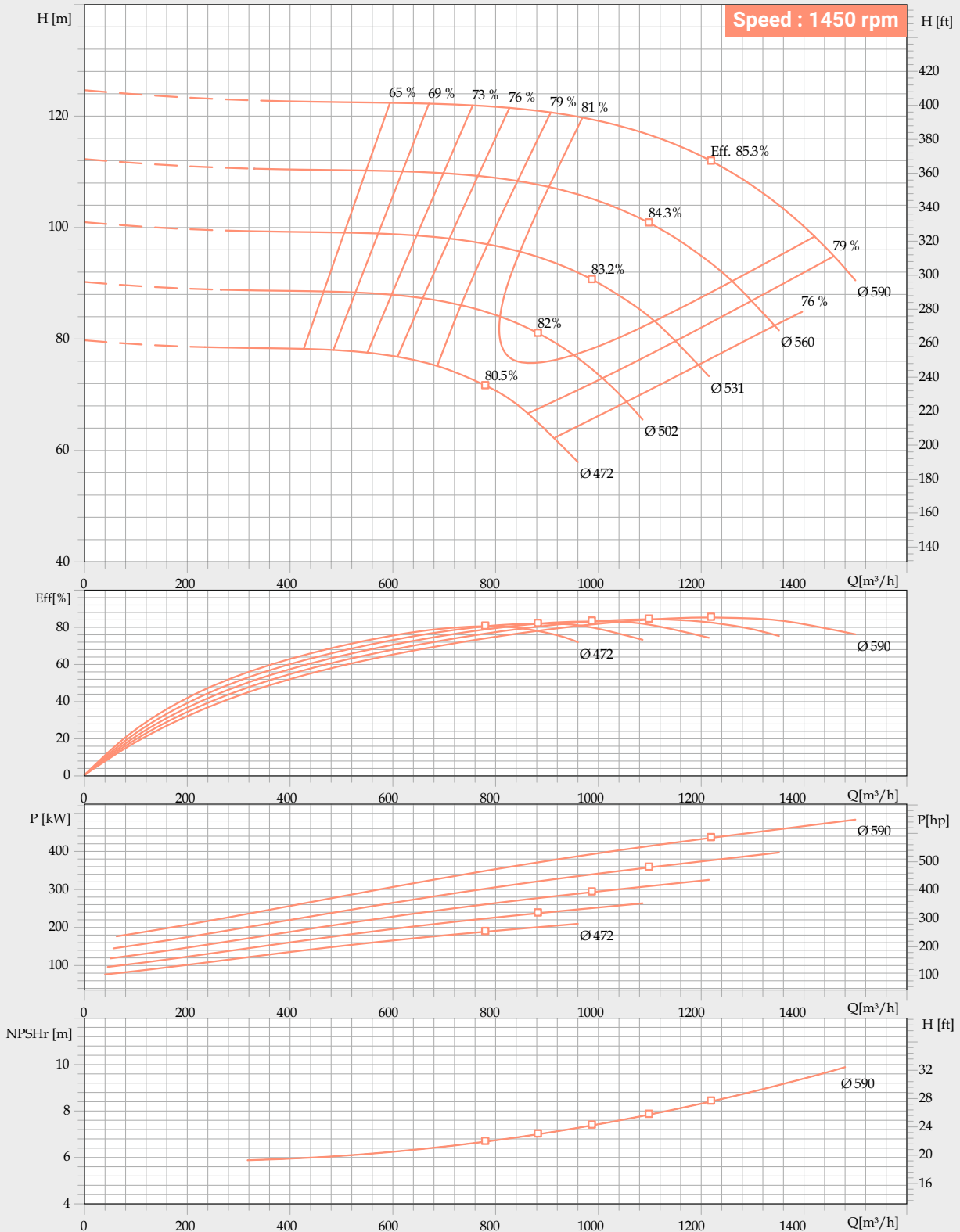

Performance to tolerance as per ISO 9906 Grade 2B.

For safety kindly consider a margin of 0.5m higher of NPSH.

In view of continuous development, the informations / descriptions / specification / illustration are subjected to change without notice.

PERFORMANCE CURVE

Pump Model : **FSCW-300/370**

Pump Size in mm : **300 x 300 x 370**

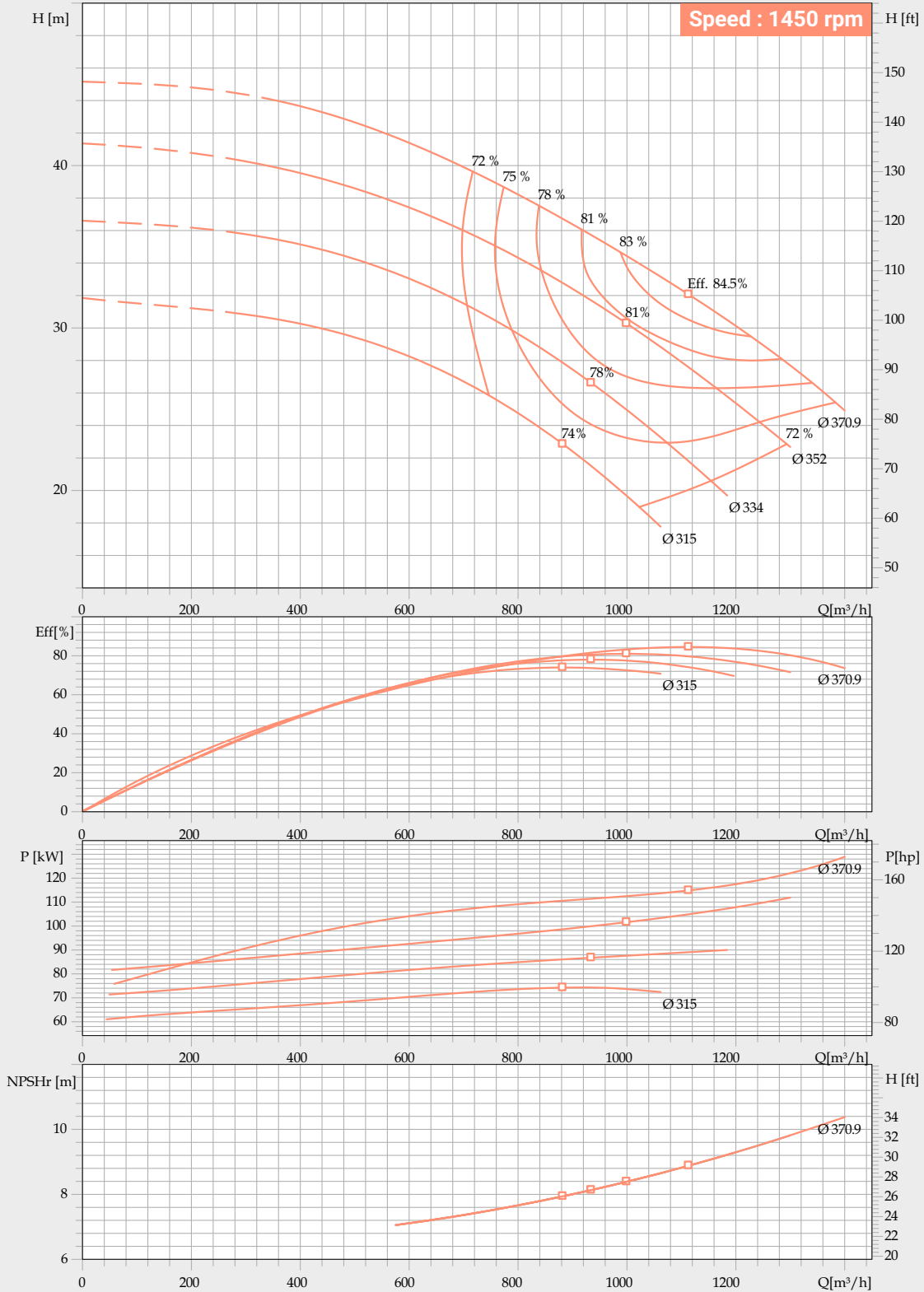

Performance to tolerance as per ISO 9906 Grade 2B.
 For safety kindly consider a margin of 0.5m higher of NPSH.
 In view of continuous development, the informations / descriptions / specification / illustration are subjected to change without notice.

PERFORMANCE CURVE

Pump Model : **FSCW-300/420**

Pump Size in mm : **300 x 300 x 420**

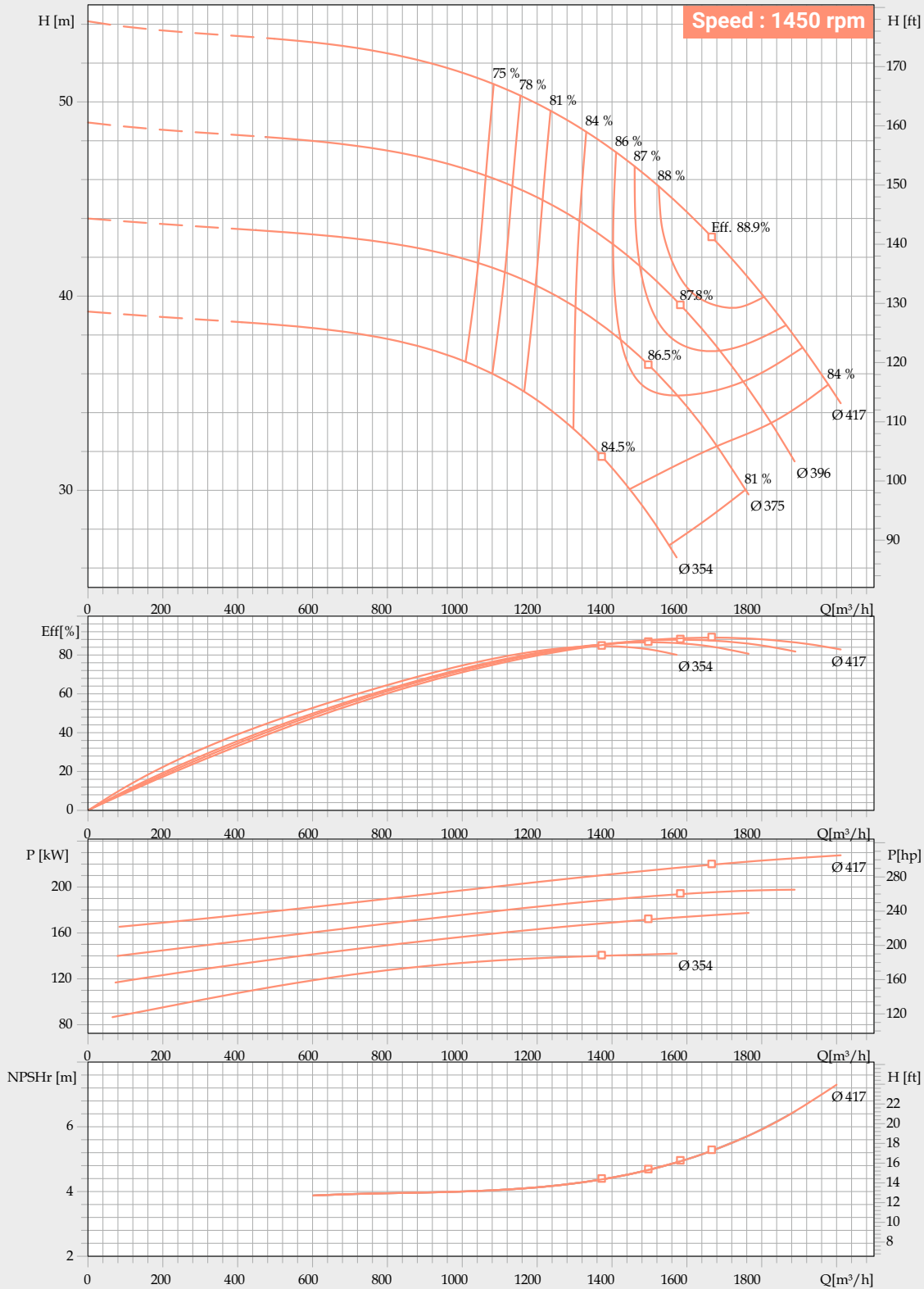

Performance to tolerance as per ISO 9906 Grade 2B.
 For safety kindly consider a margin of 0.5m higher of NPSH.
 In view of continuous development, the informations / descriptions / specification / illustration are subjected to change without notice.

PERFORMANCE CURVE

Pump Model : **FSCW-300/450**

Pump Size in mm : **300 x 300 x 450**

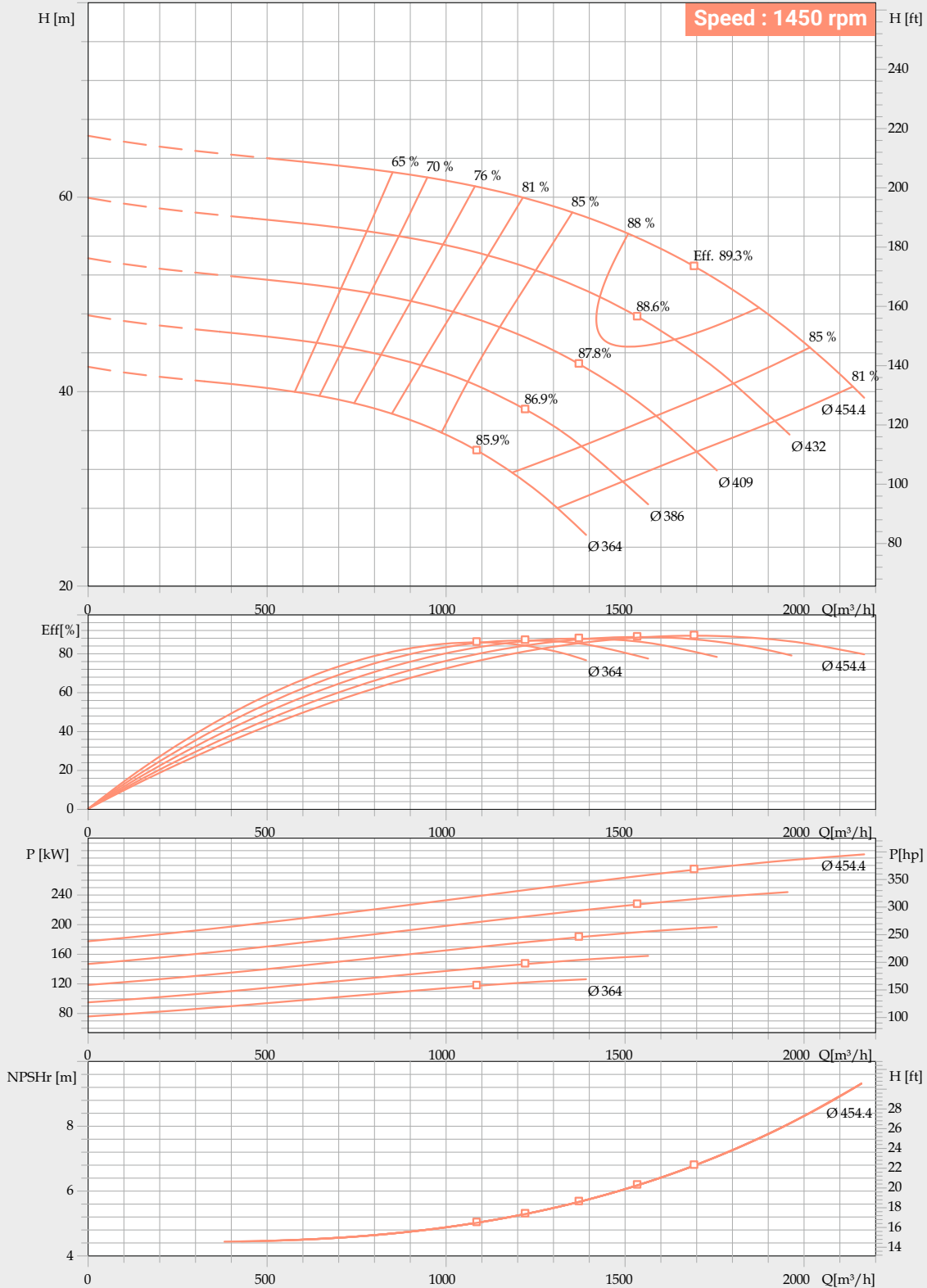

Performance to tolerance as per ISO 9906 Grade 2B.
 For safety kindly consider a margin of 0.5m higher of NPSH.
 In view of continuous development, the informations / descriptions / specification / illustration are subjected to change without notice.

PERFORMANCE CURVE

Pump Model : **FSCW-300/480**

Pump Size in mm : **350 x 300 x 480**

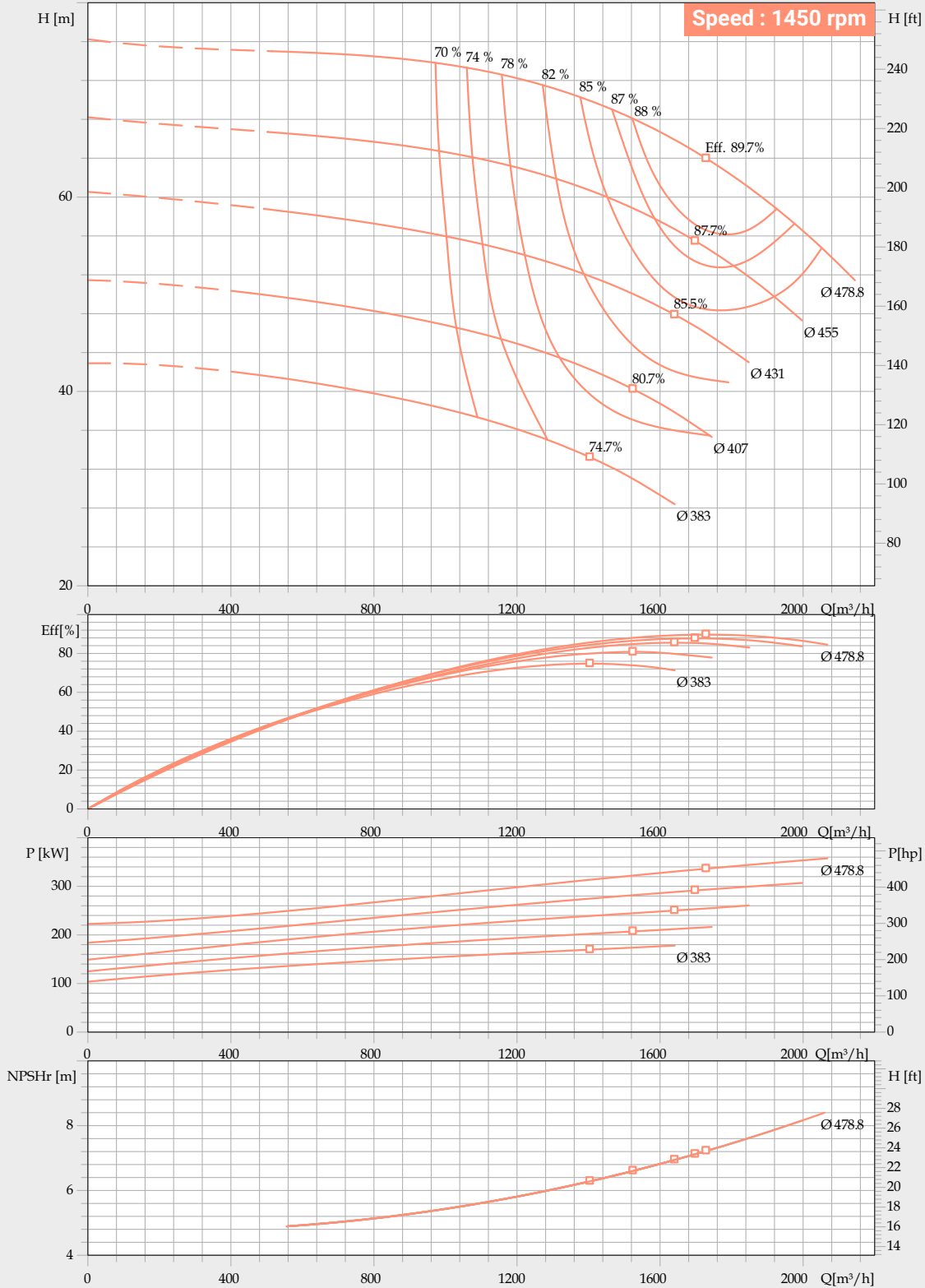

Performance to tolerance as per ISO 9906 Grade 2B.

For safety kindly consider a margin of 0.5m higher of NPSH.

In view of continuous development, the informations / descriptions / specification / illustration are subjected to change without notice.

PERFORMANCE CURVE

Pump Model : **FSCW-300/540**

Pump Size in mm : **350 x 300 x 540**

Speed : 1450 rpm

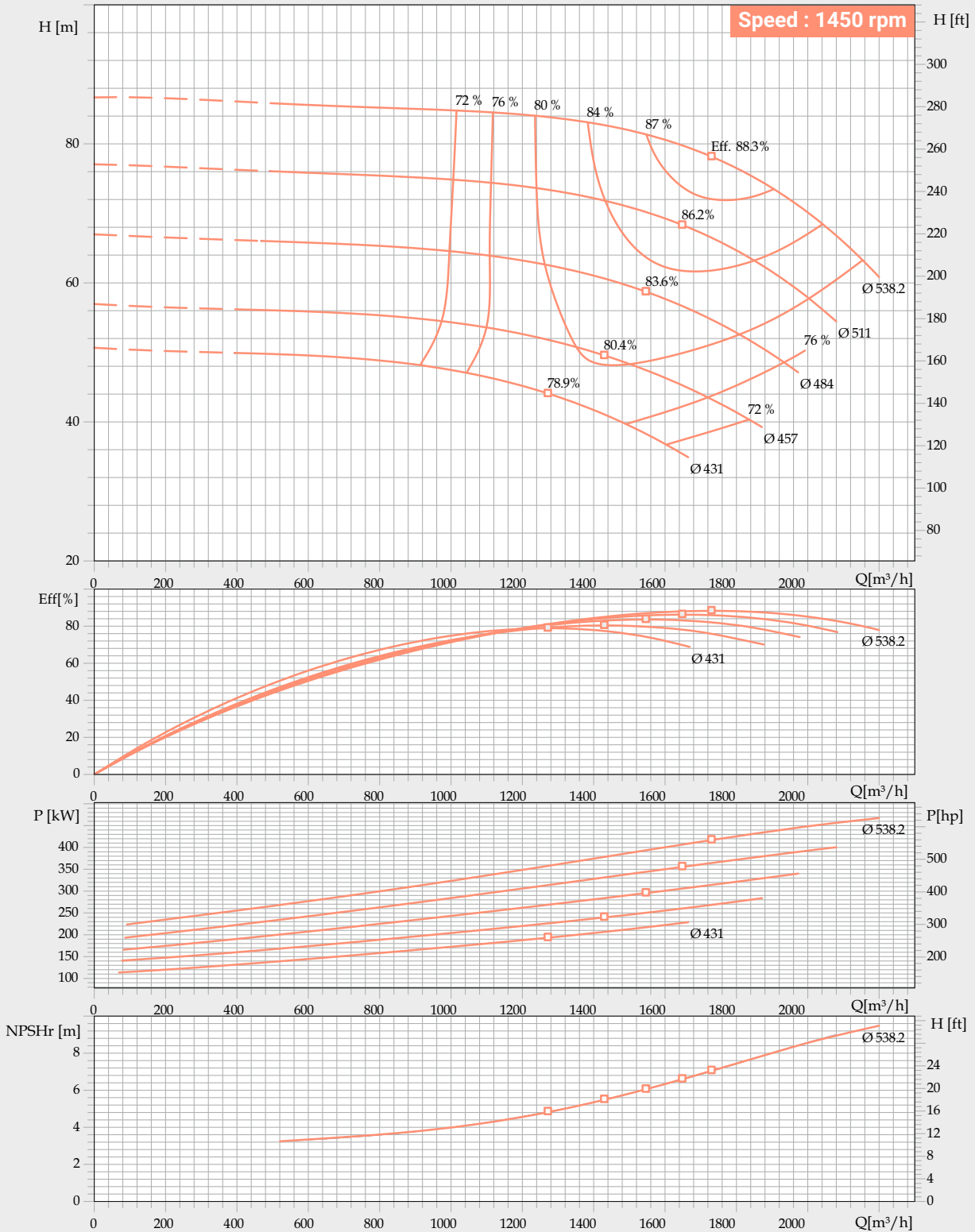

Performance to tolerance as per ISO 9906 Grade 2B.

For safety kindly consider a margin of 0.5m higher of NPSH.

In view of continuous development, the informations / descriptions / specification / illustration are subjected to change without notice.

PERFORMANCE CURVE

Pump Model : FSCW-300/600

Pump Size in mm : 350 x 300 x 600

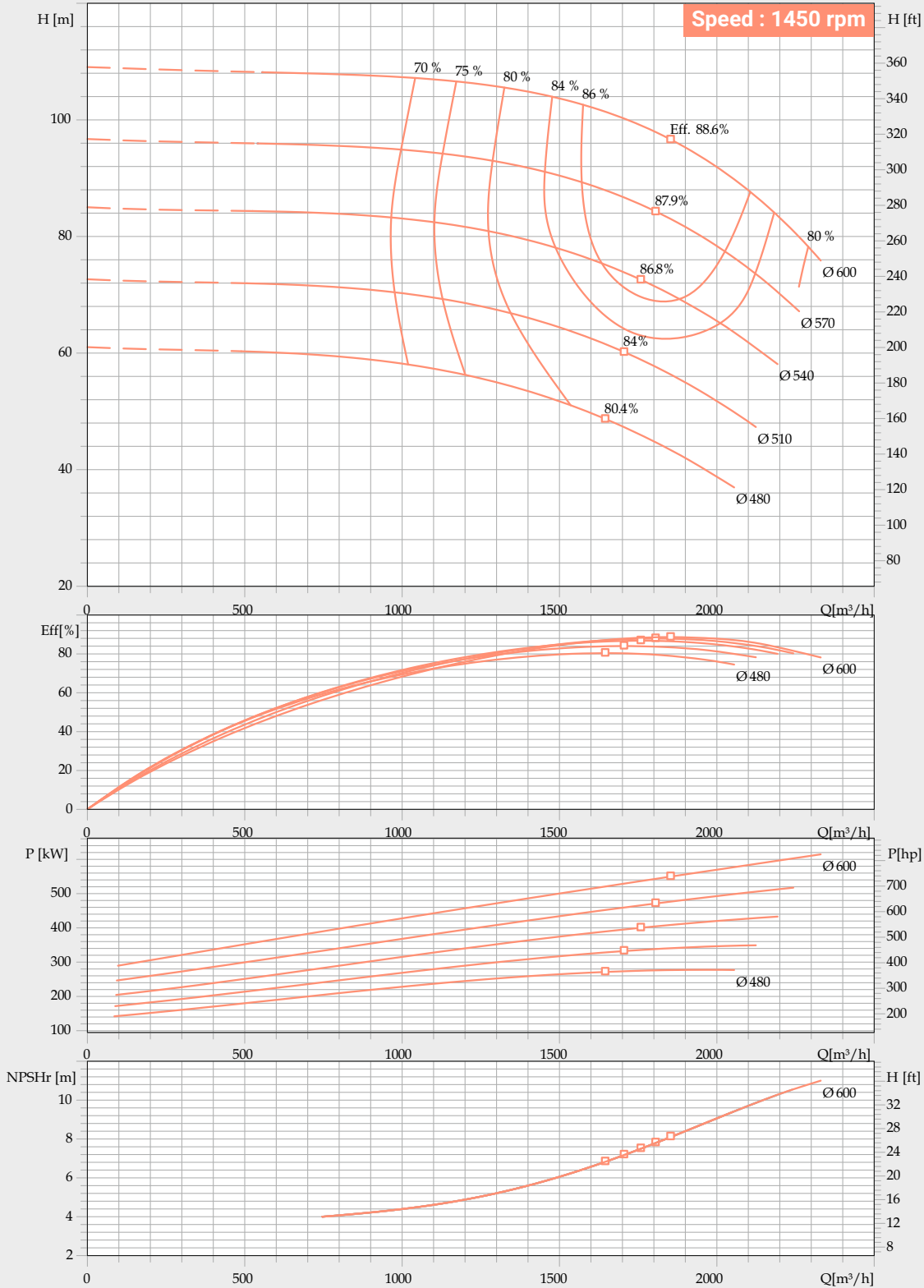

Performance to tolerance as per ISO 9906 Grade 2B.

For safety kindly consider a margin of 0.5m higher of NPSH.

In view of continuous development, the informations / descriptions / specification / illustration are subjected to change without notice.

PERFORMANCE CURVE

Pump Model : FSCW-350/530

Pump Size in mm : 400 x 350 x 530

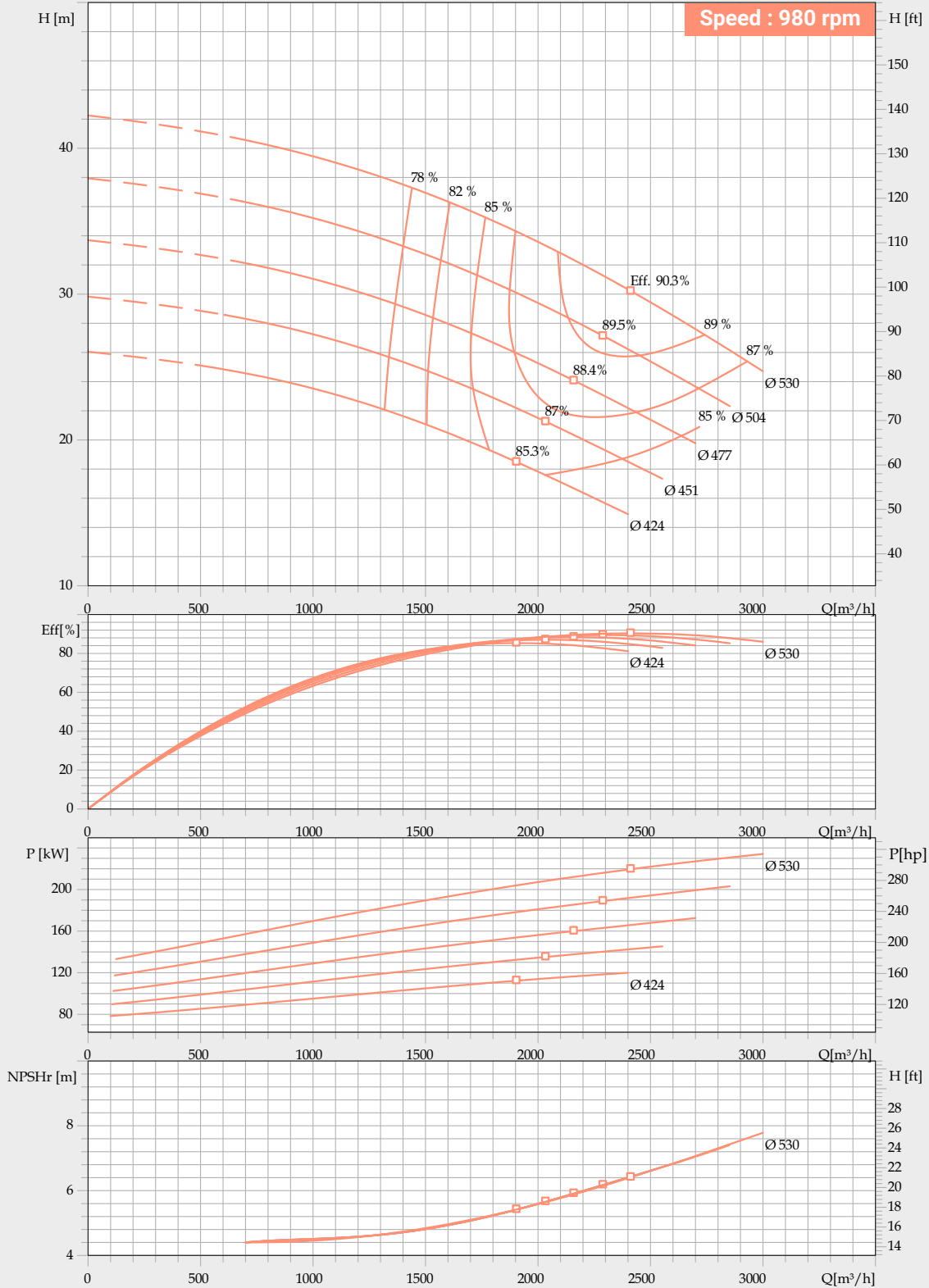

Performance to tolerance as per ISO 9906 Grade 2B.
 For safety kindly consider a margin of 0.5m higher of NPSH.
 In view of continuous development, the informations / descriptions / specification / illustration are subjected to change without notice.

PERFORMANCE CURVE

Pump Model : FSCW-350/560

Pump Size in mm : 400 x 350 x 560

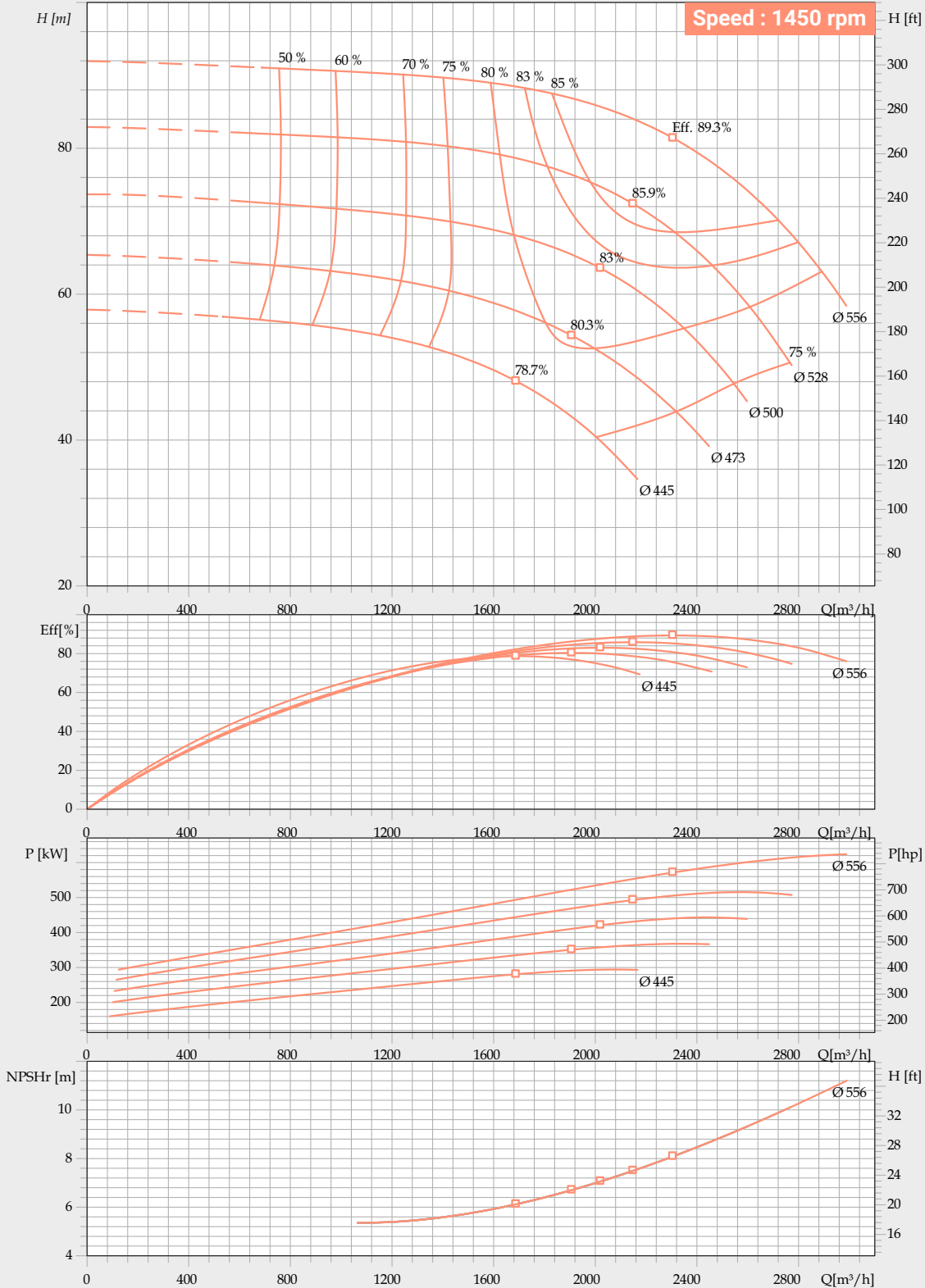

Performance to tolerance as per ISO 9906 Grade 2B.

For safety kindly consider a margin of 0.5m higher of NPSH.

In view of continuous development, the informations / descriptions / specification / illustration are subjected to change without notice.

PERFORMANCE CURVE

Pump Model : **FSCW-400/470**

Pump Size in mm : **400 x 400 x 470**

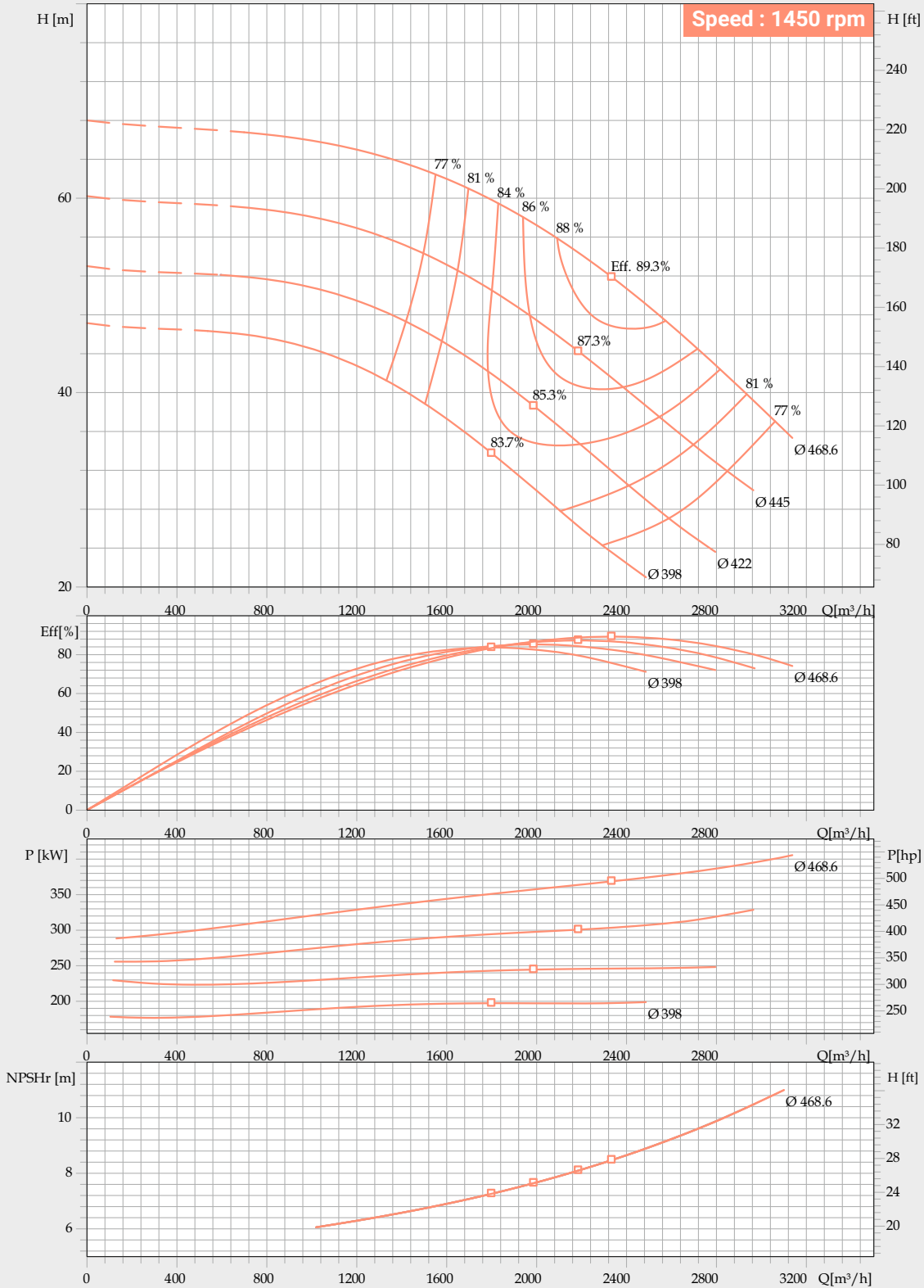

Performance to tolerance as per ISO 9906 Grade 2B.
 For safety kindly consider a margin of 0.5m higher of NPSH.
 In view of continuous development, the informations / descriptions / specification / illustration are subjected to change without notice.

PERFORMANCE CURVE

Pump Model : **FSCW-400/510**

Pump Size in mm : **400 x 400 x 510**

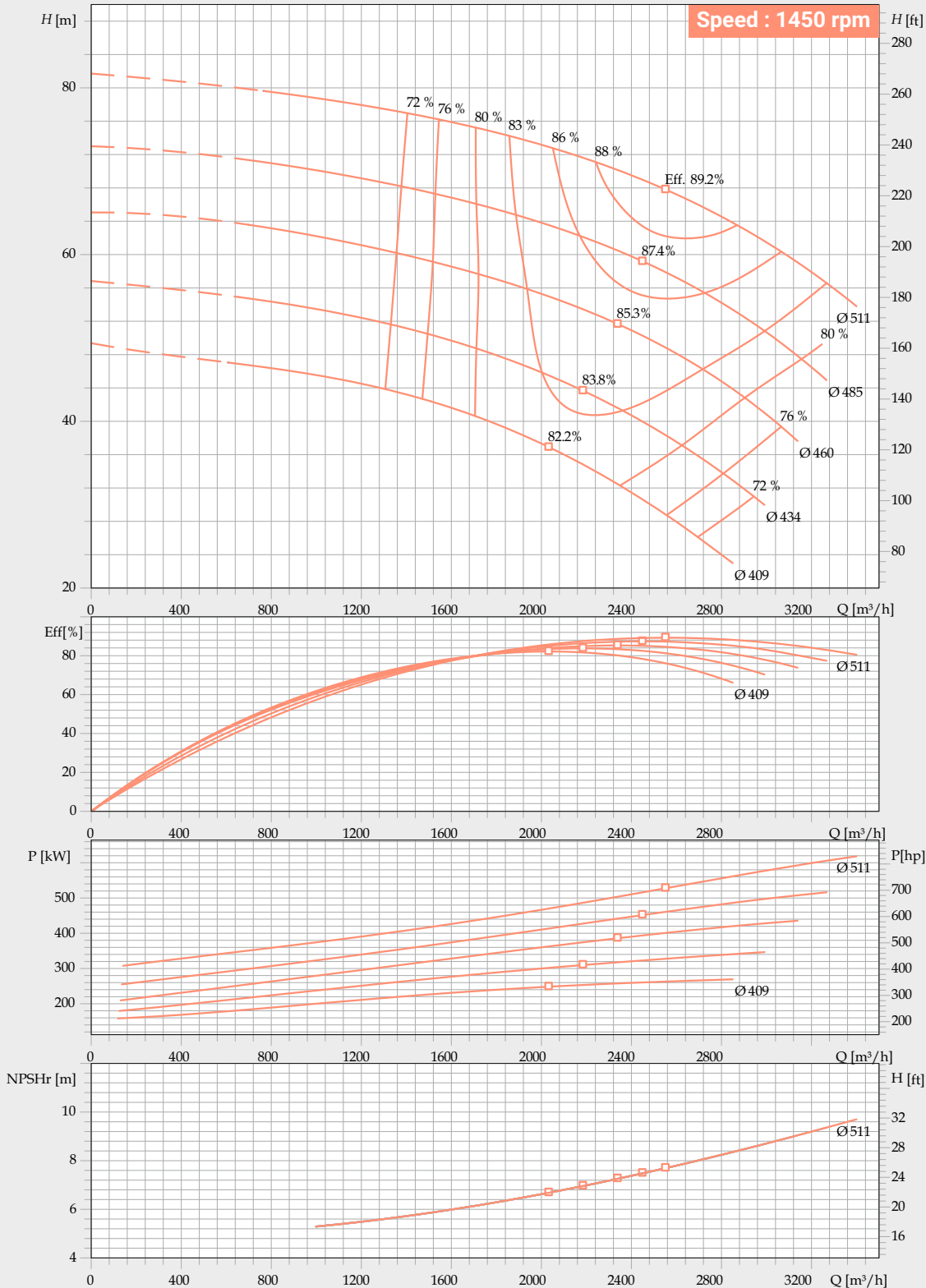

Performance to tolerance as per ISO 9906 Grade 2B.
 For safety kindly consider a margin of 0.5m higher of NPSH.
 In view of continuous development, the informations / descriptions / specification / illustration are subjected to change without notice.

PERFORMANCE CURVE

Pump Model : **FSCW-400/610**

Pump Size in mm : **400 x 400 x 610**

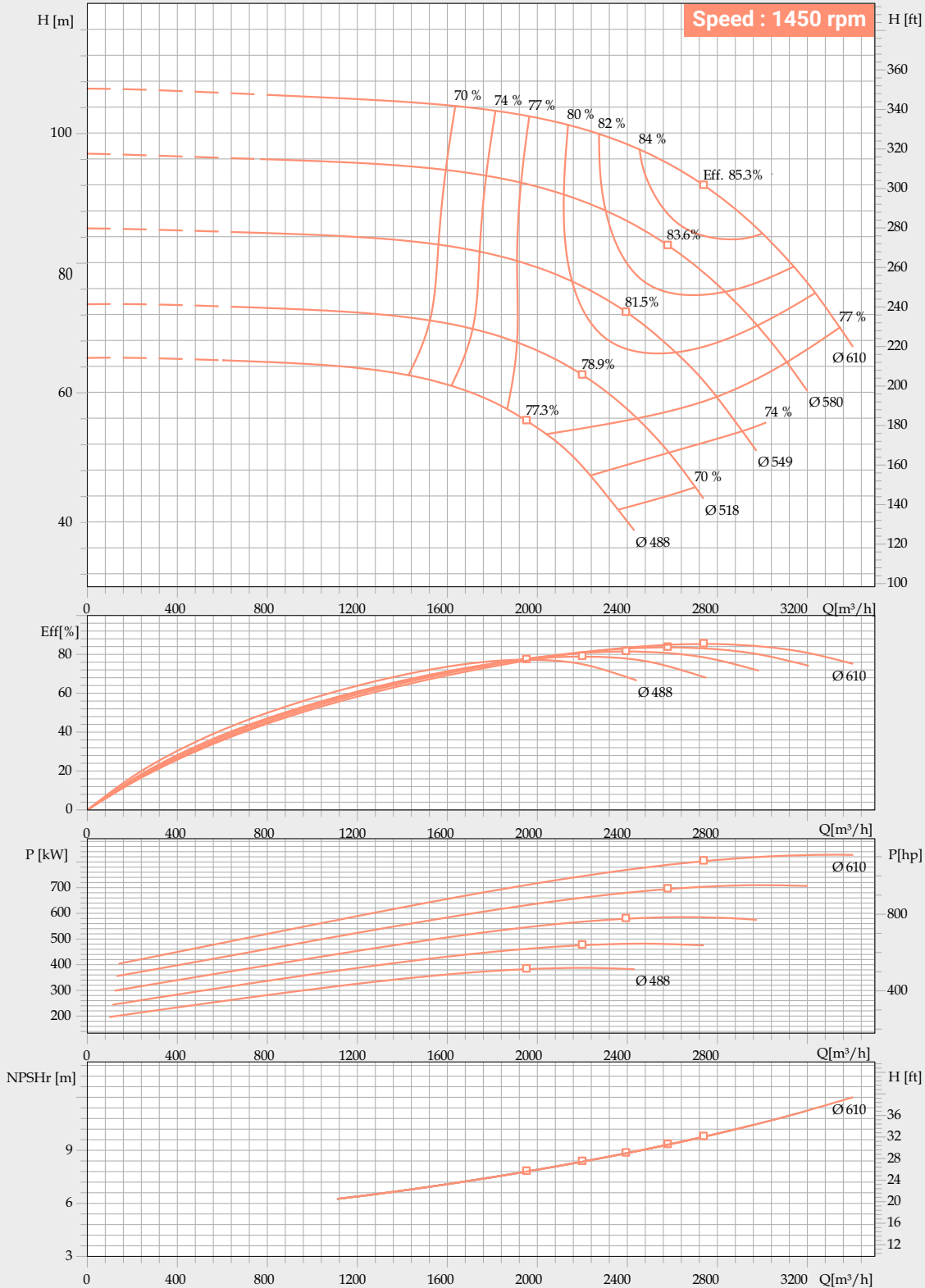

Performance to tolerance as per ISO 9906 Grade 2B.

For safety kindly consider a margin of 0.5m higher of NPSH.

In view of continuous development, the informations / descriptions / specification / illustration are subjected to change without notice.

PERFORMANCE CURVE

Pump Model : **FSCW-450/520**

Pump Size in mm : **500 x 450 x 520**

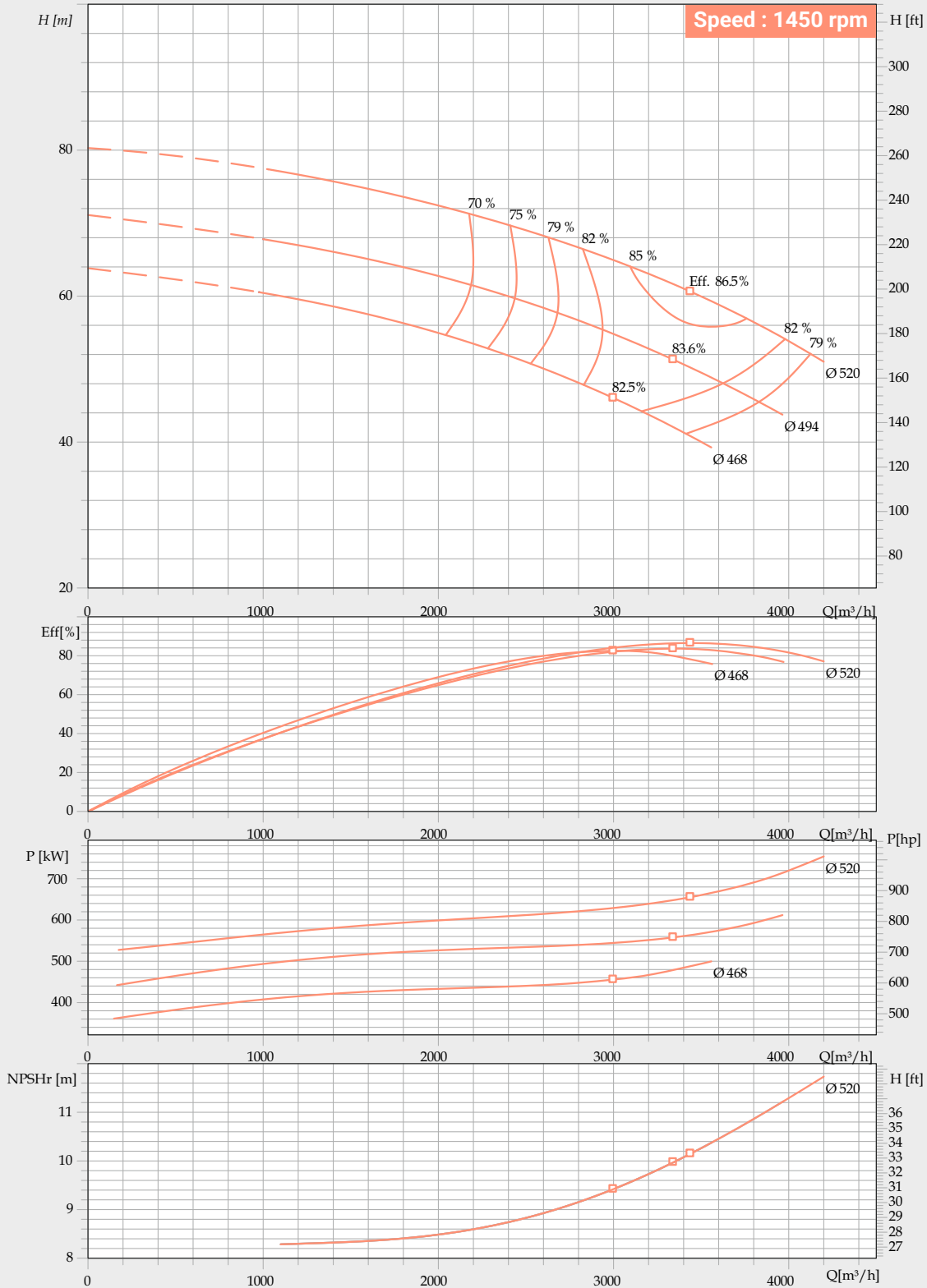

Performance to tolerance as per ISO 9906 Grade 2B.

For safety kindly consider a margin of 0.5m higher of NPSH.

In view of continuous development, the informations / descriptions / specification / illustration are subjected to change without notice.

PERFORMANCE CURVE

Pump Model : **FSCW-450/560**

Pump Size in mm : **500 x 450 x 560**

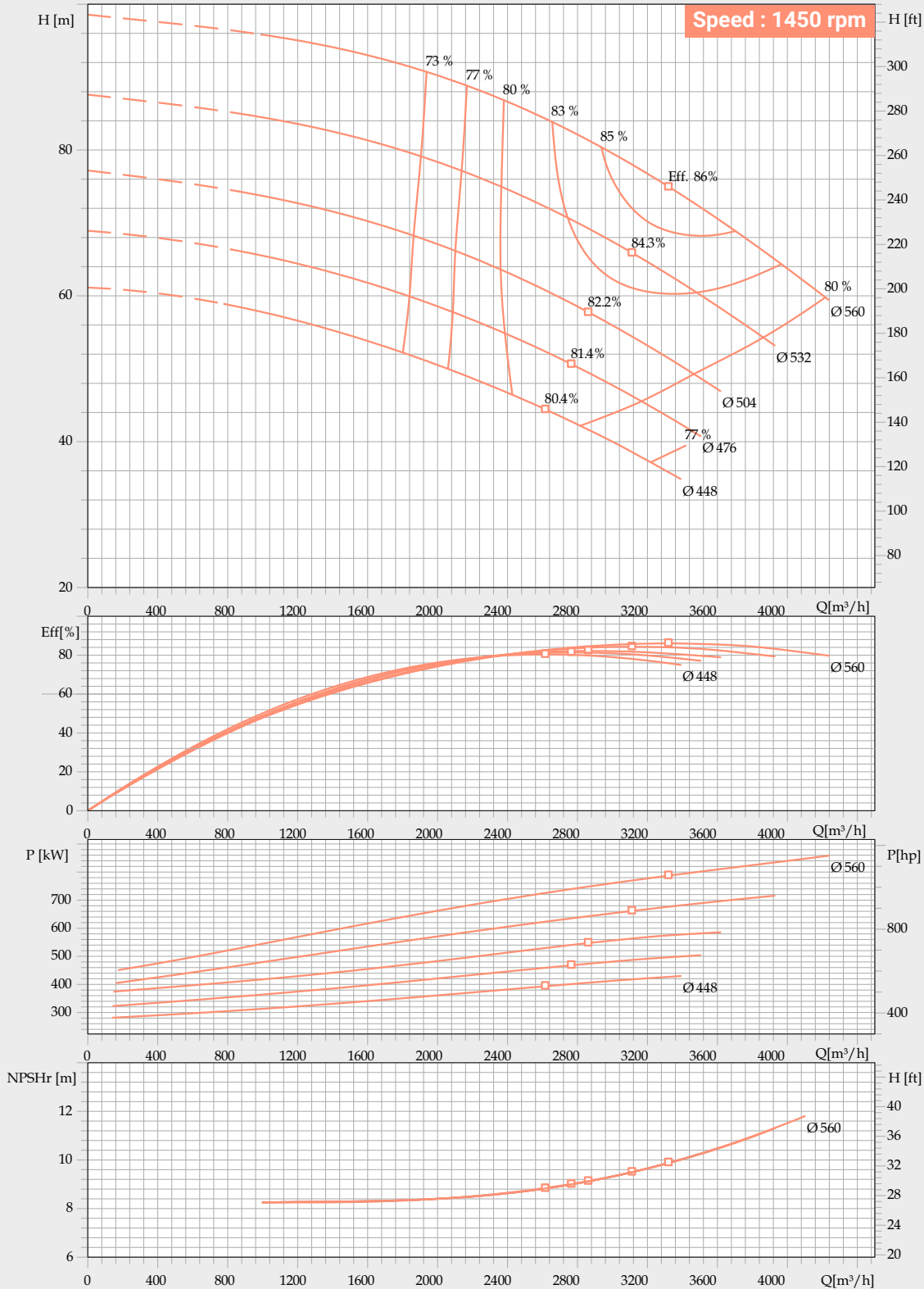

Performance to tolerance as per ISO 9906 Grade 2B.
 For safety kindly consider a margin of 0.5m higher of NPSH.
 In view of continuous development, the informations / descriptions / specification / illustration are subjected to change without notice.

GLAND PACKING CONSTRUCTION

Exploded View

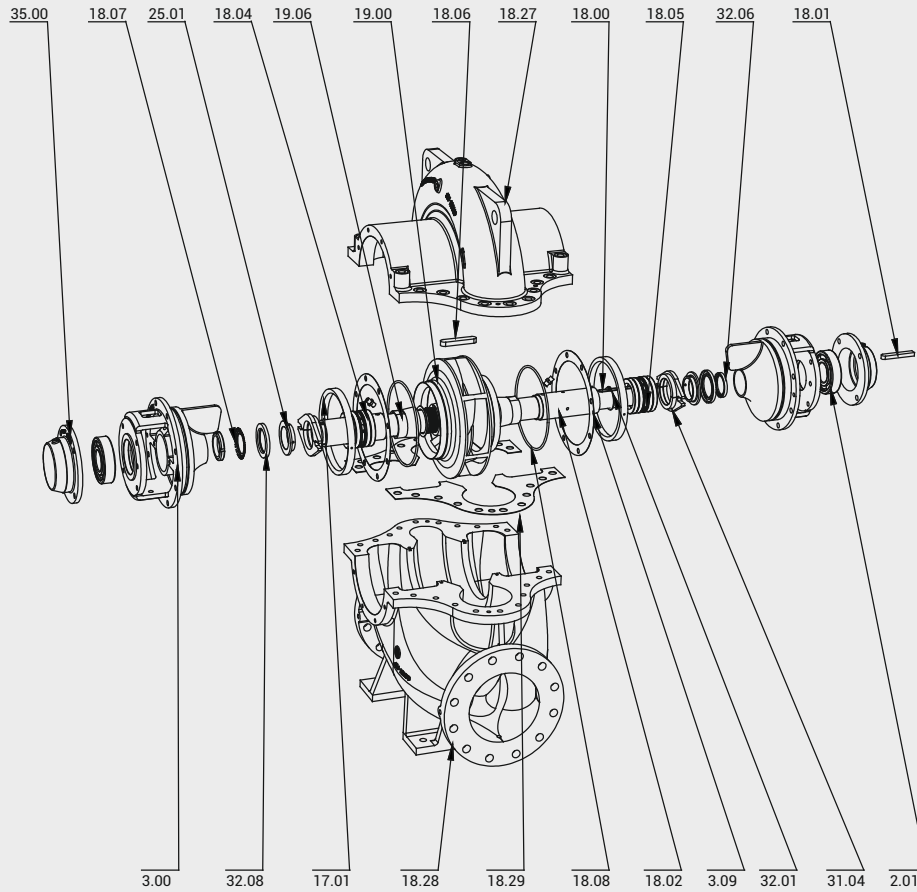

Cross Sectional View

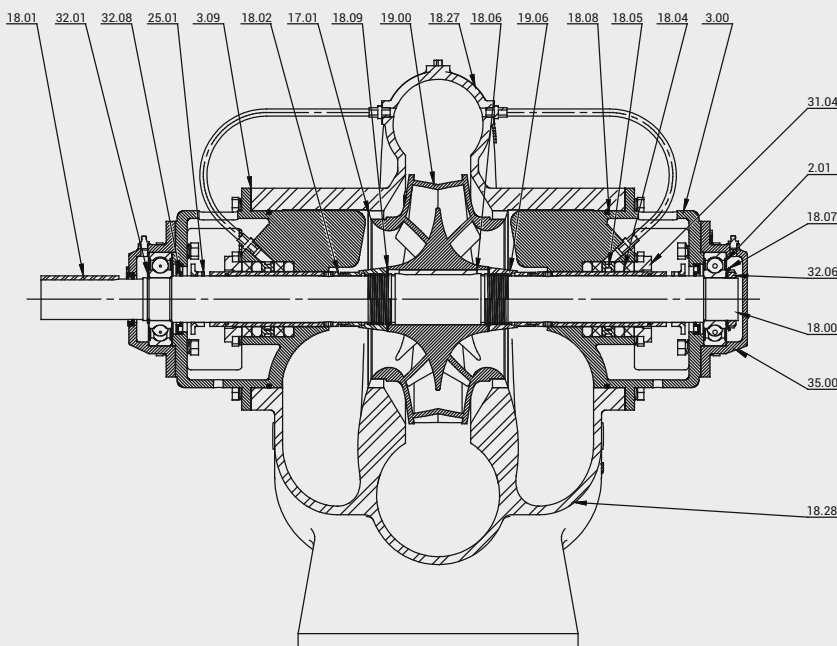

Part No	Part Name
18,27	Top Half casing
18,28	Bottom Half Casing
19,00	Impeller
3,00	Stuffing Box
17,01	Wear Ring
2,01	Deep Groove Ball Bearing
32,08	Oil Seal
18,00	Shaft
18,01	Parallel Key
18,07	Bearing Lock Washer
31,04	Gland Packing
3,09	Gasket Stuffing Box
18,06	Parallel Key
18,02	Sleeve Shaft
18,04	Packing SQ
18,05	Ring Lantern
18,09	Gasket Sleeve
35,00	Bearing Housing
32,01	Circlip
32,06	Lock Nut
18,08	O-Ring
19,06	Impeller Nut
25,01	Deflector
18,29	Gasket Casing

In view of continuous development, the informations / descriptions / specification / illustration are subjected to change without notice.

MECHANICAL SEAL CONSTRUCTION - CARTRIDGE TYPE

Exploded View

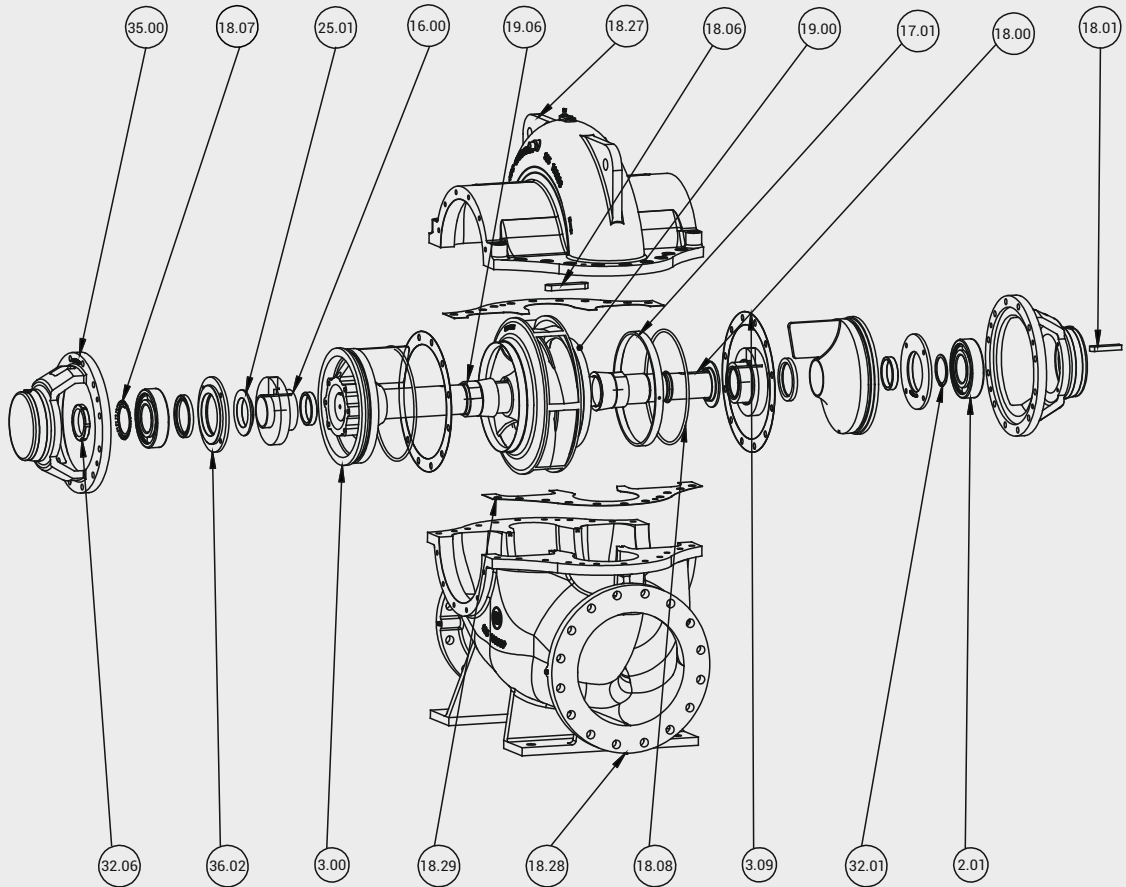

Cross Sectional View

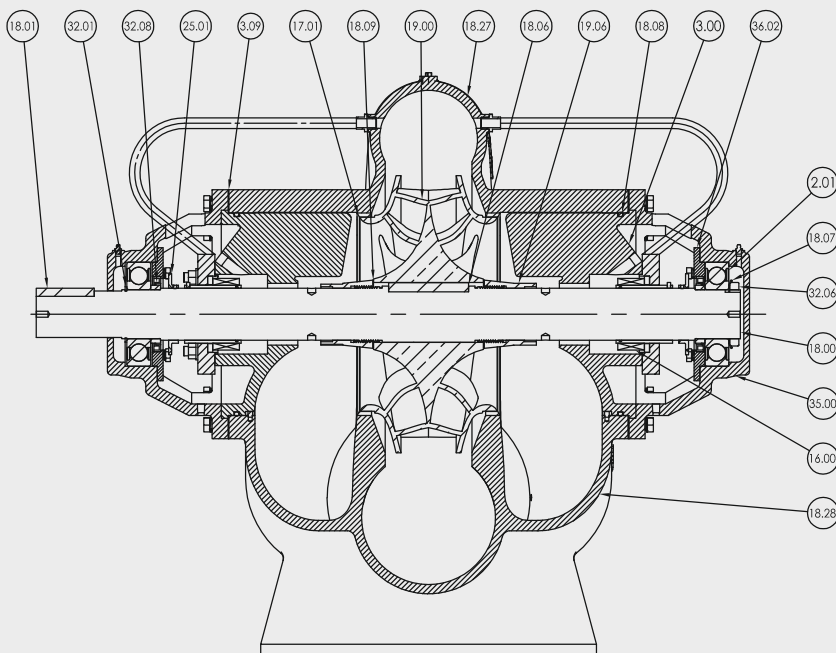

Part No	Part Name
18,27	Top Half casing
18,28	Bottom Half Casing
19,00	Impeller
3,00	Stuffing Box
17,01	Wear Ring
2,01	Deep Groove Ball Bearing
32,08	Oil Seal
18,00	Shaft
18,01	Parallel Key
18,07	Bearing Lock Washer
3,09	Gasket Stuffing Box
18,06	Parallel Key
36,02	Bearing Cover
16,00	Mechanical seal with gland
18,09	Gasket Sleeve
35,00	Bearing Housing
32,01	Circlip
32,06	Lock Nut
18,08	O-Ring
19,06	Impeller Nut
25,01	Deflector
18,29	Gasket Casing

In view of continuous development, the informations / descriptions / specification / illustration are subjected to change without notice.

MECHANICAL SEAL CONSTRUCTION - BELLOW TYPE

Exploded View

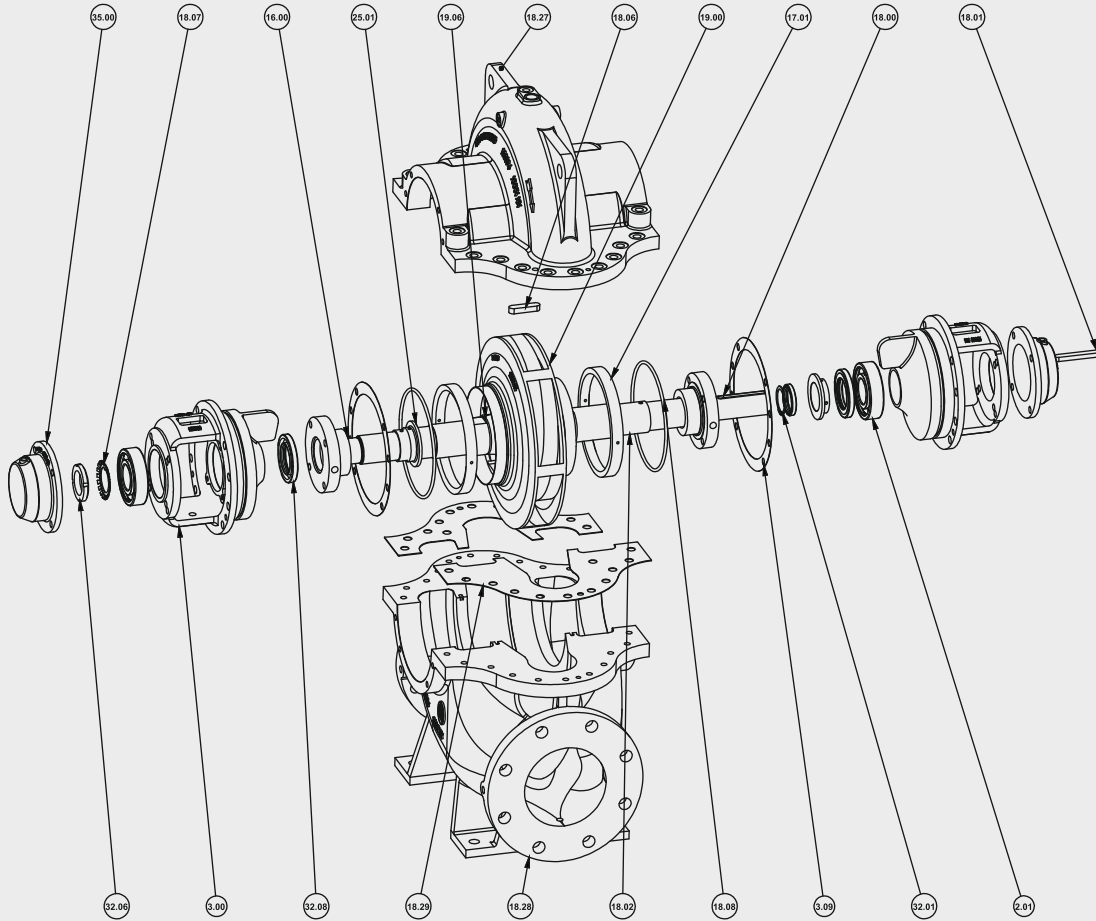



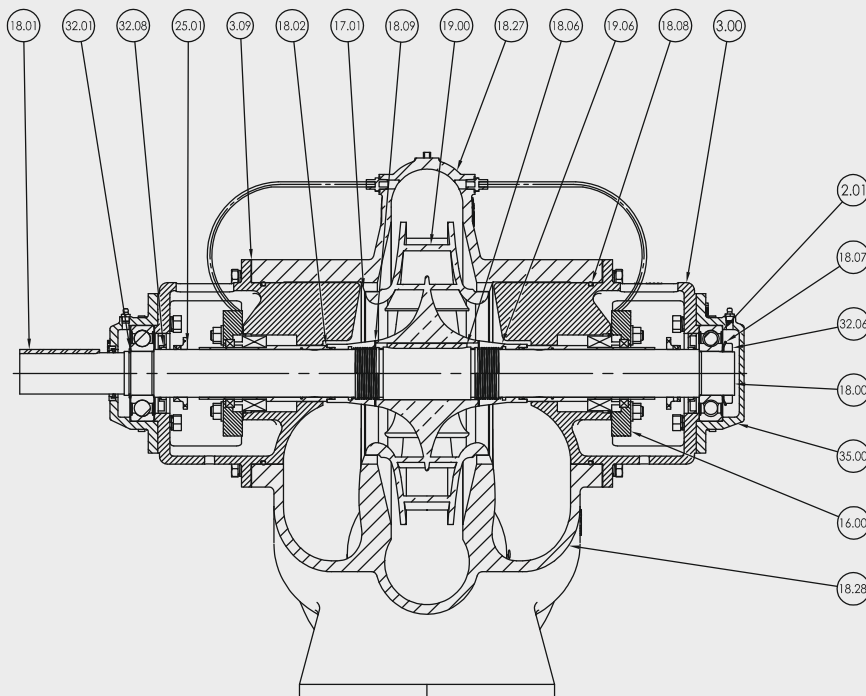





Cross Sectional View











Part No	Part Name
18,27	Top Half casing
18,28	Bottom Half Casing
19,00	Impeller
3,00	Stuffing Box
17,01	Wear Ring
2,01	Deep Groove Ball Bearing
32,08	Oil Seal
18,00	Shaft
18,01	Parallel Key
18,07	Bearing Lock Washer
3,09	Gasket Stuffing Box
18,06	Parallel Key
36,02	Bearing Cover
16,00	Mechanical seal with gland
18,09	Gasket Sleeve
35,00	Bearing Housing
32,01	Circlip
32,06	Lock Nut
18,08	O-Ring
19,06	Impeller Nut
25,01	Deflector
18,29	Gasket Casing

In view of continuous development, the informations / descriptions / specification / illustration are subjected to change without notice.

INTERCHANGEABILITY CHART

FRAME	MODEL	CASING	IMPELLER	STUFFING BOX	BEARING HOUSING	SHAFT	GLAND	BEARING
								
1	FSCW 80/285	S01	S01	S01	S01	S01	S01	6307
	FSCW 80/340	S55	S55					
	FSCW 80/220	S46	S46					
	FSCW 100/300	S02	S02	S02				
	FSCW 100/320	S08	S08					
	FSCW 100/250	S47	S47					
2	FSCW 100/305	S03	S03	S01	S03	S03	S03	6309
	FSCW 125/335	S14	S14					
	FSCW 100/280	S48	S48					
	FSCW 150/300	S04	S04	S01				
	FSCW 125/400	S10	S10					
	FSCW 125/380	S15	S15					
	FSCW 125/340	S20	S20	S57				
	FSCW 125/440	S56	S56					
	FSCW 125/470	S57	S57					
	FSCW 100/400	S53	S53	S09				
	FSCW 125/360	S09	S09					
3	FSCW 150/305	S05	S05	S05	S05	S05	S05	6311
	FSCW 150/450	S11	S11					
	FSCW 150/430	S16	S16					
	FSCW 150/380	S21	S21					
	FSCW 150/320	S50	S50					
	FSCW 150/340	S26	S26					
	FSCW 150/580	S58	S58					
	FSCW 150/530	S54	S54					
	FSCW 200/320	S06	S06	S22				
	FSCW 200/430	S22	S22					
	FSCW 200/380	S27	S27	S32				
	FSCW 200/340	S32	S32					
	FSCW 125/300	S49	S49	S49				

INTERCHANGEABILITY CHART

FRAME	MODEL	CASING	IMPELLER	STUFFING BOX	BEARING HOUSING	SHAFT	GLAND	BEARING
								
	FSCW200/540	S18	S18	S07	S07	S07	S07	6314
	FSCW250/400	S38	S38					
	FSCW250/330	S07	S07					
	FSCW250/380	S33	S33	S33				
	FSCW250/425	S28	S28					
	FSCW250/475	S23	S23					
	FSCW200/510	S12	S12	S12				
	FSCW200/460	S17	S17	S37				
	FSCW250/360	S37	S37					
	FSCW250/480	S29	S29					
	FSCW250/430	S34	S34	S34				
	FSCW300/370	S42	S42					
5	FSCW300/480	S35	S35	S35	S43	S43	S43	6317
	FSCW300/600	S25	S25					
	FSCW250/540	S24	S24	S24				
	FSCW200/570	S13	S13					
	FSCW250/590	S19	S19					
	FSCW300/420	S43	S43	S43				
	FSCW300/540	S30	S30	S39				
	FSCW300/450	S39	S39					
	FSCW400/510	S40	S40					
	FSCW400/470	S44	S44	S44				
FSCW350/530	S51	S51	S44	S44	S51			
6	FSCW350/560	S36	S36	S36	S45	S45	S45	6320
	FSCW450/520	S45	S45	S45				
	FSCW400/610	S31	S31	S31	S41			
	FSCW450/560	S41	S41	S41				

BARE SHAFT PUMP DIMENSIONS

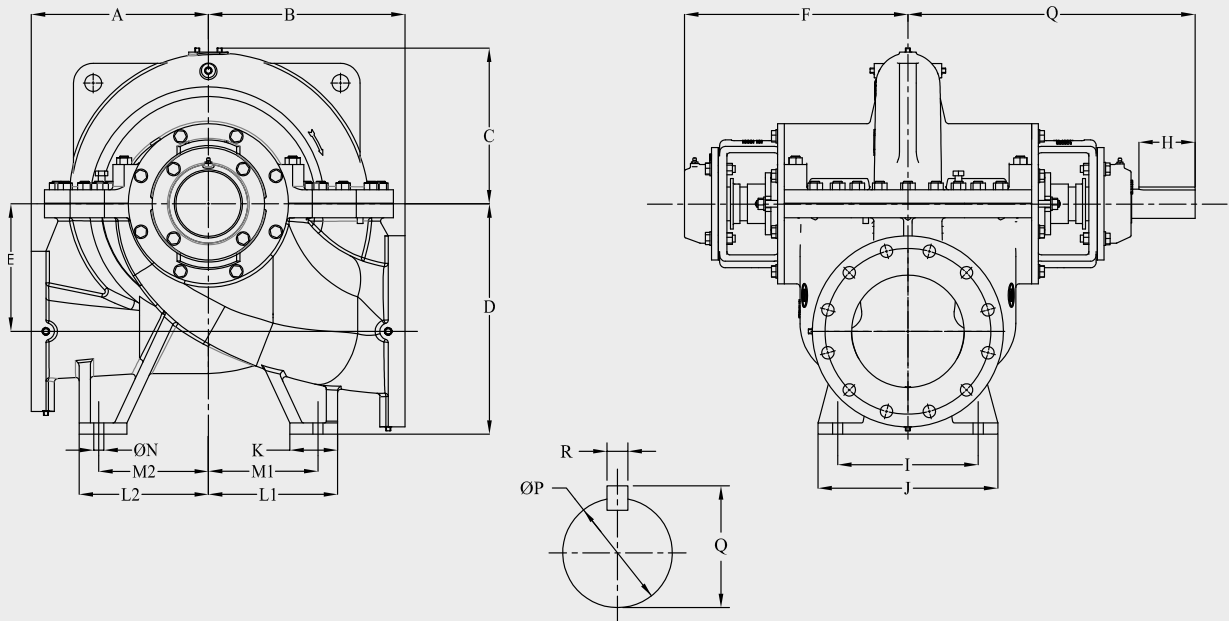

Pump Model	Pump Size	A	B	C	D	E	F	G	H	I	J	K	L1	L2	M1	M2	ØN	ØP	Q	R	WEIGHT IN KG
FSCW 80/285	80X80X285	250	250	220.5	270	167.5	266.5	350	69	180	250	75	175	175	137.5	137.5	18	32.00 31.97	35.00 34.80	10.00 9.96	108.58
FSCW 100/300	100X100X300	250	280	231.8	310	186.7	267	350	69	180	250	75	175	175	137.5	137.5	18	32.00 31.97	35.00 34.80	10.00 9.96	124.05
FSCW 100/305	125X100X305	250	280	222	320	179.6	351.3	450	84	190	250	75	175	175	140	140	18	42.00 41.97	45.00 44.80	12.00 11.96	153.11
FSCW 150/300	150X150X300	280	320	248	360	200.7	351.3	450	90	250	300	85	200	200	170	170	18	42.00 41.97	45.00 44.80	12.00 11.97	186.11
FSCW 150/305	200x150x305	300	350	267	410	215	397.5	511	100	280	350	105	220	220	170	170	18	52.00 51.97	56.00 55.80	16.00 15.96	272.65
FSCW 200/320	200X200X320	300	390	322.5	450	258	397	511	100	290	360	100	220	220	180	180	18	52.00 51.97	56.00 55.80	16.00 15.96	320.03
FSCW 250/330	250X250X330	400	450	365	510	289.4	483.5	593.5	95	440	530	120	300	300	260	260	27	65.00 64.97	69.00 68.80	18.00 17.95	499
FSCW 100/320	100X100X320	280	280	224.5	310	188.8	267	340	69	190	250	75	175	175	140	140	18	32.00 31.97	35.00 34.80	10.00 9.96	126.48
FSCW 125/360	125X125X360	320	320	257	360	211.6	351.3	450	90	240	300	75	225	225	200	200	18	42.00 41.97	45.00 44.80	12.00 11.96	202.37
FSCW 125/400	150X125X400	355	355	287	390	238	351.3	450	90	250	320	85	230	230	195	195	18	42.00 41.97	45.00 44.80	12.00 11.96	243.76
FSCW 150/450	200X150X450	400	400	340	445	262.3	397	511	100	290	350	100	250	250	212.5	212.5	18	52.00 51.97	56.00 55.80	16.00 15.96	362
FSCW 200/510	200X200X510	400	450	383	520	324.2	483.5	593.5	95	360	450	105	300	300	260	260	27	65.00 64.97	69.00 68.80	18.00 17.95	573.63
FSCW 200/570	250X200X570	500	500	423	590	350.4	553.5	678.5	100	460	560	150	375	375	310	310	27	80.01 79.99	85.00 84.80	22.00 21.95	888.93
FSCW 125/335	125X125X335	280	290	256.6	360	210.4	351.3	450	90	230	300	150	190	190	160	160	18	42.00 41.97	45.00 44.80	12.00 11.96	177.89
FSCW 125/380	150X125X380	315	340	287	395	236	352	450	90	250	320	85	230	230	195	195	18	42.00 41.97	45.00 44.80	12.00 11.96	229
FSCW 150/430	200X150X430	355	400	340.5	455	265.2	397	511	100	316	380	120	280	280	235	235	18	52.00 51.97	56.00 55.80	16.00 15.96	352.6
FSCW 200/460	200X200X460	400	400	353	490	302.2	483.5	593.5	95	370	450	120	300	300	255	255	27	65.00 64.97	69.00 68.80	18.00 17.95	488.75
FSCW 200/540	250X200X540	450	500	425	550	325.1	483.5	593.5	95	390	480	120	350	350	305	305	27	65.00 64.97	69.00 68.80	18.00 17.95	692
FSCW 250/590	300X250X590	500	500	435	630	373.8	553.5	678.5	100	410	500	150	350	350	290	290	27	80.01 79.99	85.00 84.80	22.00 21.95	949.05
FSCW 125/340	150X125X340	280	290	252	360	202	351.3	450	90	250	300	85	200	200	170	170	18	42.00 41.97	45.00 44.80	12.00 11.96	192.3
FSCW 150/380	200X150X380	315	350	277	410	227	397.5	511	100	250	320	85	230	230	195	195	18	52.00 51.97	56.00 55.80	16.00 15.96	284.29
FSCW 200/430	200X200X430	400	400	312	415	230	397.5	511	100	290	340	100	280	280	235	235	18	52.00 51.97	56.00 55.80	16.00 15.96	352.3
FSCW 250/475	250X250X475	470	430	367.5	470	254.5	483.5	593.5	95	400	480	120	300	300	255	255	27	65.00 64.97	69.00 68.80	18.00 17.95	556.99

All Dimensions are in mm, unless otherwise specified.

In view of continuous development, the informations / descriptions / specification / illustration are subjected to change without notice.

BARE SHAFT PUMP DIMENSIONS

Pump Model	Pump Size	A	B	C	D	E	F	G	H	I	J	K	L1	L2	M1	M2	ØN	ØP	Q	R	WEIGHT IN KG
FSCW 250/540	300X250X540	450	480	410.6	540	288.0	553.5	678.5	100	410	500	150	350	350	290	290	27	80.01 79.99	85.00 84.80	22.00 21.95	851.22
FSCW 300/600	350X300X600	500	600	493	725	440.1	553.5	678.5	100	500	600	150	380	380	325	325	27	80.01 79.99	85.00 84.80	22.00 21.95	1253.54
FSCW 150/340	200X150X340	315	365	285	420	235	397.5	511	100	280	350	105	220	220	170	170	18	52.00 51.97	56.00 55.80	16.00 15.96	283.66
FSCW 200/380	200X200X380	350	400	334.5	440	254	397	511	100	315	375	100	250	250	210	210	18	52.00 51.97	56.00 55.80	16.00 15.96	350.9
FSCW 250/425	250X250X425	450	450	374.5	485	267	483.5	593.5	95	400	480	120	300	300	255	255	27	65.00 64.97	69.00 68.80	18.00 17.95	546.46
FSCW 250/480	300X250X480	450	500	417.6	570	320.4	483.5	593.5	95	435	525	120	350	350	305	305	27	65.00 64.97	69.00 68.80	18.00 17.95	683.48
FSCW 300/540	350X300X540	500	575	468	650	360.1	553.5	678.5	100	480	600	150	400	400	340	340	27	80.01 79.99	85.00 84.80	22.00 21.95	1026.21
FSCW 400/610	400X400X610	570	675	538	800	477.9	662.5	812.5	130	650	800	200	460	460	350	350	27	95.00 94.97	100.00 99.80	25.00 24.95	1954.84
FSCW 200/340	200X200X340	335	375	297	425	242	397.5	511	100	300	375	100	220	220	180	180	18	52.00 51.97	56.00 55.80	16.00 15.96	323.1
FSCW 250/380	250X250X380	380	425	347	465	244.8	483.5	593.5	95	400	480	120	300	300	255	255	27	65.00 64.97	69.00 68.80	18.00 17.95	742
FSCW 250/430	300X250X430	425	500	390.5	540	290.0	483.5	593.5	95	410	500	120	300	300	250	250	27	65.00 64.97	69.00 68.80	18.00 17.95	619.95
FSCW 300/480	350X300X480	480	540	434	595	319.2	553.5	678.5	100	480	580	150	375	375	325	325	27	80.01 79.99	85.00 84.80	22.00 21.95	852.81
FSCW 350/560	400X350X560	600	650	485	705	385.8	662.5	812.5	130	700	800	200	480	480	410	410	27	95.00 94.97	100.00 99.80	25.00 24.95	1556.3
FSCW 250/360	250X250X360	400	450	340	510	290	483.5	593.5	95	390	480	120	300	300	255	255	27	65.00 64.97	69.00 68.80	18.00 17.95	493.87
FSCW 250/400	300X250X400	380	475	398	575	326	483.5	593.5	95	390	480	120	300	300	250	250	27	65.00 64.97	69.00 68.80	18.00 17.95	566.3
FSCW 300/450	350X300X450	425	525	443	645	366.4	553.5	678.5	100	550	650	150	320	320	260	260	27	80.01 79.99	85.00 84.80	22.00 21.95	865.18
FSCW 400/510	400X400X510	600	600	498	720	413.3	553.5	678.5	100	540	650	150	425	425	375	375	27	80.01 79.99	85.00 84.80	22.00 21.95	1149.79
FSCW 450/560	500X450X560	625	725	533	855	478	662.5	812.5	130	800	920	200	450	450	375	375	27	95.00 94.97	100.00 99.80	25.00 24.95	1954.2
FSCW 300/370	300X300X370	450	500	403	565	317.2	483.5	593.5	95	480	570	120	350	350	310	310	27	65.00 64.97	69.00 68.80	18.00 17.95	607.37
FSCW 300/420	350X300X420	500	550	443	640	362.6	553.5	678.5	100	540	650	150	400	400	340	340	27	80.01 79.99	85.00 84.80	22.00 21.95	837.01
FSCW 400/470	400X400X470	600	625	498	715	407.5	553.5	678.5	100	560	650	150	480	480	425	425	27	80.01 79.99	85.00 84.80	22.00 21.95	1053.11
FSCW 450/520	500X450X520	650	750	558	900	505	662.5	812.5	130	760	850	200	480	480	410	410	27	95.00 94.97	100.00 99.80	25.00 24.95	1970.86
FSCW 80/220	100X80X220	225	225	179	265	141.2	266.5	350	69	180	230	75	160	160	135	135	18	32.00 31.97	35.00 34.80	10.00 9.96	100
FSCW 100/250	125X100X250	220	250	213	305	167.9	266.5	350	69	190	240	100	160	160	125	125	18	32.00 31.97	35.00 34.80	10.00 9.96	113.34
FSCW 100/280	125X100X280	250	275	231	325	184	350.5	450	90	220	280	100	185	185	150	150	18	42.00 41.97	45.00 44.80	12.00 11.96	161.19
FSCW 125/300	150X125X300	300	300	237	350	190.5	397	511	100	310	370	105	205	205	170	170	18	52.00 51.97	56.00 55.80	16.00 15.96	239.01
FSCW 150/320	200X150X320	330	350	282	410	228	397	511	100	330	400	105	250	250	215	215	18	52.00 51.97	56.00 55.80	16.00 15.96	307.84
FSCW 350/530	400X350X530	525	725	543	770.3	450.6	600	725	100	480	600	200	550	350	450	250	27	80.01 79.99	85.00 84.80	22.00 21.95	1187.4

All Dimensions are in mm, unless otherwise specified.

In view of continuous development, the informations / descriptions / specification / illustration are subjected to change without notice.

PUMP SET DIMENSIONS

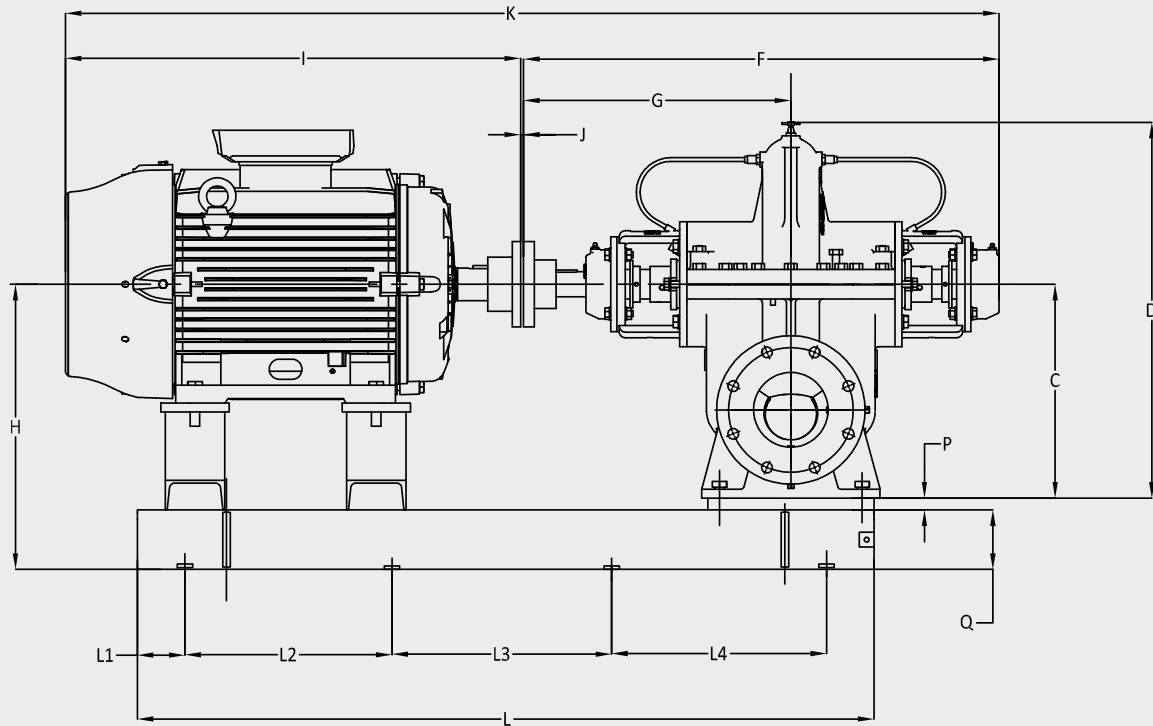

Pump Model	Motor rating (kW)			Motor Frame Size	Suction flange details				Delivery flange details			
	1450 rpm	980 rpm	2900 rpm		Nominal size (Ø A)	Pitch Circle Diameter	No. of Holes	Hole Diameter	Nominal size (Ø B)	Pitch Circle Diameter	No. of Holes	Hole Diameter
FSCW 80/285	7.5			132M	80	160	8	18	80	160	8	18
FSCW 80/285	15			160L	80	160	8	18	80	160	8	18
FSCW 80/285	11/9.3			160M	80	160	8	18	80	160	8	18
FSCW 100/300	9.3			160M	100	180	8	18	100	180	8	18
FSCW 100/300	11			160M	100	180	8	18	100	180	8	18
FSCW 100/300	15			160M	100	180	8	18	100	180	8	18
FSCW 100/300	18.5			160M	100	180	8	18	100	180	8	18
FSCW 100/305	15			160L	125	210	8	18	100	180	8	18
FSCW 100/305	18.5			180M	125	210	8	18	100	180	8	18
FSCW 100/305	22			180M	125	210	8	18	100	180	8	18
FSCW 100/305	30			200L	125	210	8	18	100	180	8	18
FSCW 150/300	15			160L	150	240	8	22	150	240	8	22
FSCW 150/300	18.5			180M	150	240	8	22	150	240	8	22
FSCW 150/300	22			180L	150	240	8	22	150	240	8	22
FSCW 150/300	30			200L	150	240	8	22	150	240	8	22
FSCW 150/305	45			ND225M	200	295	12	22	150	240	8	22
FSCW 150/305	37			ND225S	200	295	12	22	150	240	8	22
FSCW 150/305	30			ND200L	200	295	12	22	150	240	8	22
FSCW 150/305	22			ND180L	200	295	12	22	150	240	8	22
FSCW 200/320	55			ND250M	200	295	12	22	200	295	12	22
FSCW 200/320	45			ND225M	200	295	12	22	200	295	12	22
FSCW 200/320	37			ND225S	200	295	12	22	200	295	12	22
FSCW 200/320	30			ND200L	200	295	12	22	200	295	12	22
FSCW 250/330	75			ND280S	250	355	12	26	250	355	12	26
FSCW 250/330	55			ND250M	250	355	12	26	250	355	12	26
FSCW 250/330	45			ND225M	250	355	12	26	250	355	12	26
FSCW 250/330	37			ND225S	250	355	12	26	250	355	12	26
FSCW 100/320	30			200L	100	180	8	18	100	180	8	18
FSCW 100/320	22			180L	100	180	8	18	100	180	8	18
FSCW 100/320	18.5			180M	100	180	8	18	100	180	8	18
FSCW 100/320	15			160L	100	180	8	18	100	180	8	18
FSCW 125/360	45			225M	250	355	12	26	250	355	12	26
FSCW 125/360	37			225S	250	355	12	26	250	355	12	26

All Dimensions are in mm, unless otherwise specified.

In view of continuous development, the informations / descriptions / specification / illustration are subjected to change without notice.

PUMP SET DIMENSIONS

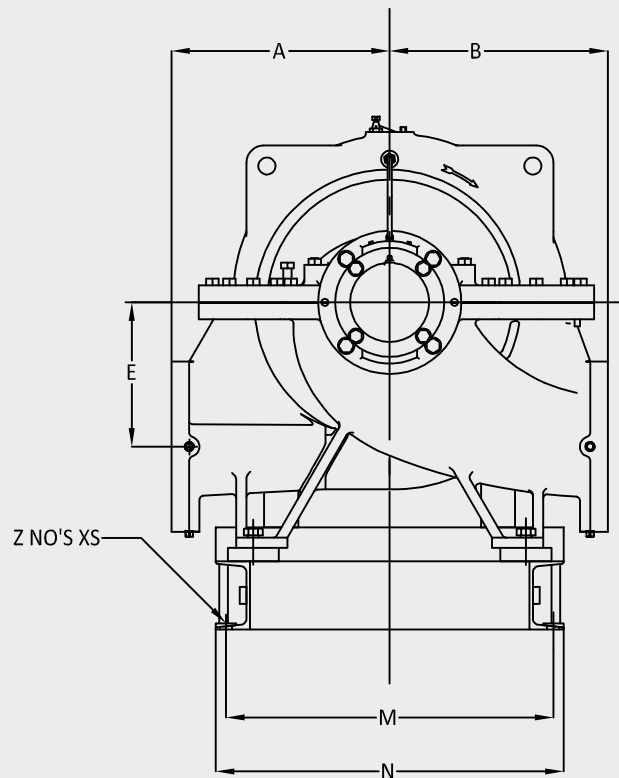

Side view

Pump General Dimension													Foundation Dimension								
A	B	C	D	E	F	G	H	I	J	K	M	N	L	L1	L2	L3	L4	P	Q	Z No's	S
250	250	270	490.5	167.5	616.5	350	365	510	5	1131.5	295	315	875	100	337.5	337.5		20	75	6	14
250	250	270	490.5	167.5	616.5	350	365	510	5	1131.5	295	315	1000	100	400	400		20	75	6	14
250	250	270	490.5	167.5	616.5	350	365	605	5	1226.5	295	315	875	100	337.5	337.5		20	75	6	14
250	280	310	541.8	186.7	617	350	405	605	5	1227	335	365	950	80	395	395		20	75	6	14
250	280	310	541.8	186.7	617	350	405	605	5	1227	335	365	950	80	395	395		20	75	6	14
250	280	310	541.8	186.7	617	350	405	650	5	1227	335	365	990	80	415	415		20	75	6	14
250	280	310	541.8	186.7	617	350	405	677	5	1299	335	365	990	80	415	415		20	75	6	14
250	280	320	542	179.6	801.3	450	415	650	5	1456.3	340	370	1100	80	470	470		20	75	6	14
250	280	320	542	179.6	801.3	450	415	650	5	1483	340	370	1100	80	470	470		20	75	6	14
250	280	320	542	179.6	801.3	450	415	715	5	1521.3	340	370	1130	80	485	485		20	75	6	14
250	280	320	542	179.6	801.3	450	440	790	5	1596.3	340	370	1130	80	520	520		20	75	6	18
280	320	360	608	200.7	801.3	450	455	650	5	1456.3	400	430	1150	80	495	495		20	75	6	14
280	320	360	608	200.7	801.3	450	455	677	5	1483.3	400	430	1120	80	480	480		20	75	6	14
280	320	360	608	200.7	801.3	450	455	650	5	1521.3	400	430	1180	80	510	510		20	75	6	14
280	320	360	608	200.7	801.3	450	480	790	5	1596.3	400	430	1240	80	540	540		20	75	6	18
300	350	410	677	215	908.5	511	530	865	5	1778.5	464	500	1420	100	610	610		20	100	6	18
300	350	410	677	215	908.5	511	530	840	5	1753.5	464	500	1400	100	600	600		20	100	6	18
300	350	410	677	215	908.5	511	530	790	5	1703.5	464	500	1350	100	575	575		20	100	6	18
300	350	410	677	215	908.5	511	530	715	5	1628.5	464	500	1350	100	575	575		20	100	6	18
300	390	450	772.5	258	908	511	620	940	5	1853	514	550	1419	100	609.5	609.5		20	150	6	18
300	390	450	772.5	258	908	511	570	865	5	1778	464	500	1430	100	615	615		20	100	6	18
300	390	450	772.5	258	908	511	570	840	5	1753	464	500	1410	100	605	605		20	100	6	18
300	390	450	772.5	258	908	511	570	790	5	1703	464	500	1360	100	580	580		20	100	6	18
400	450	510	875	289.4	1077	593.5	730	1035	5	2117	564	600	1760	100	780	780		20	200	6	18
400	450	510	875	289.4	1077	593.5	680	940	5	2022	564	600	1670	100	735	735		20	150	6	18
400	450	510	875	289.4	1077	593.5	680	865	5	1947	564	600	1580	100	690	690		20	150	6	18
400	450	510	875	289.4	1077	593.5	680	840	5	1922	564	600	1580	100	690	690		20	150	6	18
280	280	310	534.5	188.8	607	340	430	790	5	1402	360	390	1100	80	470	470		20	100	6	14
280	280	310	534.5	188.8	607	340	405	715	5	1327	340	370	1030	80	435	435		20	75	6	14
280	280	310	534.5	188.8	607	340	405	677	5	1289	340	370	1000	80	420	420		20	75	6	14
280	280	310	534.5	188.8	607	340	405	650	5	1262	340	370	980	80	410	410		20	75	6	14
320	320	360	617	211.6	801.3	450	480	865	5	1671.3	480	510	1310	80	575	575		20	100	6	14
320	320	360	617	211.6	801.3	450	480	840	5	1646.3	480	510	1270	80	555	555		20	100	6	18

All Dimensions are in mm, unless otherwise specified.

In view of continuous development, the informations / descriptions / specification / illustration are subjected to change without notice.

PUMP SET DIMENSIONS

Pump Model	Motor rating (kW)			Motor Frame Size	Suction flange details				Delivery flange details			
	1450 rpm	980 rpm	2900 rpm		Nominal size (Ø A)	Pitch Circle Diameter	No. of Holes	Hole Diameter	Nominal size (Ø B)	Pitch Circle Diameter	No. of Holes	Hole Diameter
FSCW 125/360	30	-	-	200L	250	355	12	26	250	355	12	26
FSCW 125/360	-	-	-	180L	250	355	12	26	250	355	12	26
FSCW 125/400	75	-	-	280S	150	240	8	22	125	210	8	18
FSCW 125/400	-	-	-	250M	150	240	8	22	125	210	8	18
FSCW 125/400	45	-	-	225M	150	240	8	22	125	210	8	18
FSCW 125/400	-	-	-	225S	150	240	8	22	125	210	8	18
FSCW 150/450	132	-	-	ND315M	200	295	12	22	150	240	8	22
FSCW 150/450	-	-	-	ND315S	200	295	12	22	150	240	8	22
FSCW 150/450	90	-	-	ND280M	200	295	12	22	150	240	8	22
FSCW 150/450	-	-	-	ND280S	200	295	12	22	150	240	8	22
FSCW 200/510	225	-	-	ND355L	200	295	12	22	200	295	12	22
FSCW 200/510	-	-	-	ND315L	200	295	12	22	200	295	12	22
FSCW 200/510	160	-	-	ND315LX	200	295	12	22	200	295	12	22
FSCW 200/510	-	-	-	ND315M	200	295	12	22	200	295	12	22
FSCW 200/510	110	-	-	ND315S	200	295	12	22	200	295	12	22
FSCW 200/570	-	-	-	355ML	250	355	12	26	200	295	12	22
FSCW 200/570	335 / 275	-	-	ND355LX	250	355	12	26	200	295	12	22
FSCW 200/570	-	-	-	ND355L	250	355	12	26	200	295	12	22
FSCW 200/570	200	-	-	ND315LX	250	355	12	26	200	295	12	22
FSCW 125/335	-	-	-	200L	125	210	8	18	125	210	8	18
FSCW 125/335	22	-	-	180L	125	210	8	18	125	210	8	18
FSCW 125/335	-	-	-	180M	125	210	8	18	125	210	8	18
FSCW 125/380	55	-	-	ND250M	150	240	8	22	125	210	8	18
FSCW 125/380	-	-	-	ND225M	150	240	8	22	125	210	8	18
FSCW 125/380	37	-	-	ND225S	150	240	8	22	125	210	8	18
FSCW 125/380	-	-	-	ND200L	150	240	8	22	125	210	8	18
FSCW 150/430	90	-	-	ND280M	200	295	12	22	150	240	8	22
FSCW 150/430	-	-	-	ND280S	200	295	12	22	150	240	8	22
FSCW 150/430	55	-	-	ND250M	200	295	12	22	150	240	8	22
FSCW 200/460	-	-	-	ND315LX	200	295	12	22	200	295	12	22
FSCW 200/460	132	-	-	ND315M	200	295	12	22	200	295	12	22
FSCW 200/460	-	-	-	ND315S	200	295	12	22	200	295	12	22
FSCW 200/540	180	-	-	ND315L	250	355	12	26	200	295	12	22
FSCW 200/540	-	-	-	ND315LX	250	355	12	26	200	295	12	22
FSCW 200/540	132	-	-	ND315M	250	355	12	26	200	295	12	22
FSCW 200/540	-	-	-	ND315S	250	355	12	26	200	295	12	22
FSCW 200/540	90	-	-	ND280M	250	355	12	26	200	295	12	22
FSCW 250/590	-	-	-	355LK	300	410	12	26	250	355	12	26
FSCW 250/590	450 / 400	-	-	355ML	300	410	12	26	250	355	12	26
FSCW 250/590	-	-	-	ND355LX	300	410	12	26	250	355	12	26
FSCW 125/340	45	-	-	225M	150	240	8	22	125	210	8	18
FSCW 125/340	-	-	-	225S	150	240	8	22	125	210	8	18
FSCW 125/340	30	-	-	200L	150	240	8	22	125	210	8	18
FSCW 125/340	-	-	-	180L	150	240	8	22	125	210	8	18
FSCW 150/380	75	-	-	280S	200	295	12	22	150	240	8	22
FSCW 150/380	-	-	-	250M	200	295	12	22	150	240	8	22
FSCW 150/380	45	-	-	225M	200	295	12	22	150	240	8	22
FSCW 150/380	-	-	-	225S	200	295	12	22	150	240	8	22
FSCW 200/430	132	-	-	315M	200	295	12	22	200	295	12	22
FSCW 200/430	-	-	-	315S	200	295	12	22	200	295	12	22
FSCW 200/430	90	-	-	280M	200	295	12	22	200	295	12	22
FSCW 200/430	-	-	-	280S	200	295	12	22	200	295	12	22
FSCW 250/475	200/160	-	-	ND315LX	250	355	12	26	250	355	12	26
FSCW 250/475	-	-	-	ND315L	250	355	12	26	250	355	12	26
FSCW 250/475	132	-	-	ND315M	250	355	12	26	250	355	12	26
FSCW 250/475	-	-	-	ND315S	250	355	12	26	250	355	12	26
FSCW 250/540	400	-	-	355ML	300	410	12	26	250	355	12	26
FSCW 250/540	-	-	-	ND355LX	300	410	12	26	250	355	12	26
FSCW 250/540	200	-	-	ND315LX	300	410	12	26	250	355	12	26
FSCW 300/600	-	-	-	400L	350	470	16	26	300	410	12	26
FSCW 300/600	500	-	-	355LK	350	470	16	26	300	410	12	26
FSCW 300/600	-	-	-	355ML	350	470	16	26	300	410	12	26
FSCW 300/600	360/315	-	-	ND355LX	350	470	16	26	300	410	12	26
FSCW 150/340	-	-	-	250M	200	295	12	22	150	240	8	22
FSCW 150/340	45	-	-	225M	200	295	12	22	150	240	8	22
FSCW 150/340	-	-	-	225S	200	295	12	22	150	240	8	22
FSCW 150/340	30	-	-	200L	200	295	12	22	150	240	8	22
FSCW 200/380	-	-	-	ND280M	200	295	12	22	200	295	12	22
FSCW 200/380	75	-	-	ND280S	200	295	12	22	200	295	12	22
FSCW 200/380	-	-	-	ND250M	200	295	12	22	200	295	12	22
FSCW 200/380	45	-	-	ND225M	200	295	12	22	200	295	12	22
FSCW 250/425	-	-	-	ND315LX	250	355	12	26	250	355	12	26
FSCW 250/425	132	-	-	ND315M	250	355	12	26	250	355	12	26
FSCW 250/425	-	-	-	ND315S	250	355	12	26	250	355	12	26
FSCW 250/425	90	-	-	ND280M	250	355	12	26	250	355	12	26
FSCW 250/480	-	-	-	ND355LX	300	410	12	26	250	355	12	26
FSCW 250/480	225	-	-	ND355L	300	410	12	26	250	355	12	26
FSCW 250/480	-	-	-	ND315LX/315L	300	410	12	26	250	355	12	26
FSCW 300/540	450/400	-	-	355ML	350	470	16	26	300	410	12	26
FSCW 300/540	-	-	-	ND355LX	350	470	16	26	300	410	12	26
FSCW 400/610	630/560	-	-	400L	400	525	16	30	400	525	16	30

All Dimensions are in mm, unless otherwise specified.

In view of continuous development, the informations / descriptions / specification / illustration are subjected to change without notice.

PUMP SET DIMENSIONS

Pump General Dimension													Foundation Dimension								
A	B	C	D	E	F	G	H	I	J	K	M	N	L	L1	L2	L3	L4	P	Q	Z No's	S
320	320	360	617	211.6	801.3	450	480	790	5	1596.3	480	510	1240	80	540	540		20	100	6	18
320	320	360	617	211.6	801.3	450	480	715	5	1521.3	480	510	1200	80	520	520		20	100	6	18
355	355	390	677	238	801.3	450	510	1035	5	1841.3	530	560	1398	80	619	619		20	100	6	18
355	355	390	677	238	801.3	450	510	940	5	1746.3	470	500	1340	80	590	590		20	100	6	18
355	355	390	677	238	801.3	450	510	865	5	1671.3	470	500	1300	80	570	570		20	100	6	18
355	355	390	677	238	801.3	450	510	840	5	1646.3	470	500	1265	80	552.5	552.5		20	100	6	18
400	400	445	785	262.3	908	511	615	1230	5	2143	574	610	1800	100	800	800		20	150	6	18
400	400	445	785	262.3	908	511	615	1180	5	2093	574	610	1750	100	775	775		20	150	6	18
400	400	445	785	262.3	908	511	615	1085	5	1998	574	610	1670	100	735	735		20	150	6	18
400	400	445	785	262.3	908	511	615	1035	5	1948	574	610	1620	100	710	710		20	150	6	18
400	450	520	903	324.2	1077	593.5	790	1513	5	2595	684	720	2200	100	1000	1000		20	250	6	18
400	450	520	903	324.2	1077	593.5	740	1295	5	2377	674	710	1950	100	875	875		20	200	6	18
400	450	520	903	324.2	1077	593.5	740	1390	5	2472	674	710	1950	100	875	875		20	200	6	18
400	450	520	903	324.2	1077	593.5	740	1230	5	2312	674	710	1950	100	875	875		20	200	6	18
400	450	520	903	324.2	1077	593.5	740	1180	5	2262	674	710	1850	100	825	825		20	200	6	18
500	500	590	1013	350.5	1232	678.5	860	1584	5	2821	784	820	2450	100	1125	1125		20	250	8	22
500	500	590	1013	350.5	1232	678.5	860	1580	5	2817	784	820	2300	100	1050	1050		20	250	8	22
500	500	590	1013	350.5	1232	678.5	860	1513	5	2750	784	820	2370	100	1085	1085		20	250	8	22
500	500	590	1013	350.5	1232	678.5	860	1390	5	2627	784	820	2150	100	975	975		20	250	8	22
280	290	360	616.6	210.4	450	801.3	480	790	5	1596.3	400	430	1220	80	530	530		20	100	6	18
280	290	360	616.6	210.4	450	801.3	480	715	5	1521.3	400	430	1150	80	495	495		20	100	6	18
280	290	360	616.6	210.4	450	801.3	480	677	5	1483.3	400	430	1110	80	475	475		20	100	6	18
315	340	395	682	236	450	802	515	940	5	1747	484	520	1440	100	620	620		20	100	6	18
315	340	395	682	236	450	802	515	865	5	1672	484	520	1320	100	560	560		20	100	6	18
315	340	395	682	236	450	802	515	840	5	1647	484	520	1320	100	560	560		20	100	6	18
315	340	395	682	236	450	802	515	790	5	1597	484	520	1210	100	505	505		20	100	6	18
355	400	455	795.5	265.2	908	511	625	1085	5	1998	508	544	1600	100	700	700		20	150	6	18
355	400	455	795.5	265.2	908	511	625	1035	5	1948	508	544	1600	100	700	700		20	150	6	18
355	400	455	795.5	265.2	908	511	625	940	5	1853	508	544	1500	100	650	650		20	150	6	18
400	400	490	843	302.2	1077	593.5	710	1390	5	2472	584	620	2080	100	940	940		20	200	6	18
400	400	490	843	302.2	1077	593.5	710	1230	5	2312	584	620	2080	100	940	940		20	200	6	18
400	400	490	843	302.2	1077	593.5	710	1180	5	2262	584	620	1850	100	825	825		20	200	6	18
450	500	550	975	325.1	1077	593.5	770	1295	5	2377	354	390	1960	100	880	880		20	200	6	18
450	500	550	975	325.1	1077	593.5	770	1390	5	2472	354	390	2050	100	925	925		20	200	6	18
450	500	550	975	325.1	1077	593.5	770	1230	5	2312	354	390	1950	100	875	875		20	200	6	18
450	500	550	975	325.1	1077	593.5	770	1180	5	2262	354	390	1900	100	850	850		20	200	6	18
450	500	550	975	325.1	1077	593.5	770	1085	5	2167	354	390	1800	100	800	800		20	200	6	18
500	500	630	1065	373.8	1232	678.5	900	1834	5	3071	704	750	2700	100	1250	1250		20	250	8	22
500	500	630	1065	373.8	1232	678.5	900	1584	5	2821	704	750	2400	100	1100	1100		20	250	8	22
500	500	630	1065	373.8	1232	678.5	900	1580	5	2817	704	750	2200	100	1000	1000		20	250	8	22
280	290	360	612	202	801.3	450	480	865	5	1671.3	420	450	1300	80	570	570		20	100	6	18
280	290	360	612	202	801.3	450	480	840	5	1646.3	420	450	1260	80	550	550		20	100	6	18
280	290	360	612	202	801.3	450	480	790	5	1596.3	420	450	1240	80	540	540		20	100	6	18
280	290	360	612	202	801.3	450	455	715	5	1521.3	400	430	1180	80	510	510		20	100	6	14
315	350	410	687	227	908.5	511	530	1035	5	1948.5	530	560	1460	80	650	650		20	100	6	18
315	350	410	687	227	908.5	511	530	940	5	1853.5	470	500	1410	80	625	625		20	100	6	18
315	350	410	687	227	908.5	511	530	865	5	1778.5	470	500	1370	80	605	605		20	100	6	18
315	350	410	687	227	908.5	511	530	840	5	1753.5	470	500	1330	80	585	585		20	100	6	18
400	400	415	727	230	908.5	511	535	1230	5	2143.5	590	620	1700	80	770	770		20	100	6	18
400	400	415	727	230	908.5	511	535	1180	5	2093.5	590	620	1620	80	730	730		20	100	6	18
400	400	415	727	230	908.5	511	535	1085	5	1988.5	550	580	1580	80	710	710		20	100	6	18
400	400	415	727	230	908.5	511	535	1035	5	1948.5	550	580	1480	80	660	660		20	100	6	18
470	430	470	837.5	254.5	1077	593.5	640	1390	5	2472	689	725	2050	100	925	925		20	150	6	18
470	430	470	837.5	254.5	1077	593.5	640	1295	5	2377	689	725	2050	100	925	925		20	150	6	18
470	430	470	837.5	254.5	1077	593.5	640	1230	5	2312	689	725	1950	100	875	875		20	150	6	18
470	430	470	837.5	254.5	1077	593.5	640	1180	5	2262	689	725	1900	100	850	850		20	150	6	18
450	480	540	950.6	288	1232	678.5	810	1584	5	2821	704	740	2400	100	1100	1100	1100	20	250	8	22
450	480	540	950.6	288	1232	678.5	760	1580	5	2817	735	770	2310	100	1055	1055	1055	20	200	8	22
450	480	540	950.6	288	1232	678.5	760	1390	5	2627	735	775	2130	100	965	965	965	20	200	8	22
500	600	725	1218	440.1	1819	678.5	995	1891	5	3128	824	860	2700	150	800	800	800	20	250	8	22
500	600	725	1218	440.1	1232	678.5	995	1834	5	3071	824	860	2700	150	800	800	800	20	250	8	22
500	600	725	1218	440.1	1232	678.5	995	1584	5	2821	824	860	2400	700	700	700	700	20	250	8	22
500	600	725	1218	440.1	1232	678.5	995	1580	5	2817	824	860	2300	175	650	650	650	20	250	8	22
315	365	420	687	235	908.5	511	540	940	5	1853.5	460	490	1425	80	632.5	632.5		20	100	6	18
315	365	420	687	235	908.5	511	540	865	5	1778.5	420	450	1385	80	612.5	612.5		20	100	6	18
315	365	420	687	235	908.5	511	540	840	5	1753.5	420	450	1345	80	592.5	592.5		20	100	6	18
315	365	420	687	235	908.5	511	540	790	5	1703.5	420	450	1300	80	570	570		20	100	6	18
350	400	440	774.5	254	908	511	610	1085	5	1998	574	610	161								

PUMP SET DIMENSIONS

Pump Model	Motor rating (kW)			Motor Frame Size	Suction flange details				Delivery flange details			
	1450 rpm	980 rpm	2900 rpm		Nominal size (Ø A)	Pitch Circle Diameter	No. of Holes	Hole Diameter	Nominal size (Ø B)	Pitch Circle Diameter	No. of Holes	Hole Diameter
FSCW 400/610	450			355ML	400	525	16	30	400	525	16	30
FSCW 400/610	900/800			450L	400	525	16	30	400	525	16	30
FSCW 200/340	75			280S	200	295	12	22	200	295	12	22
FSCW 200/340	55			250M	200	295	12	22	200	295	12	22
FSCW 200/340	45			225M	200	295	12	22	200	295	12	22
FSCW 200/340	37			225S	200	295	12	22	200	295	12	22
FSCW 250/380	110			ND315S	250	355	12	26	250	355	12	26
FSCW 250/380	90			ND280M	250	355	12	26	250	355	12	26
FSCW 250/380	75			ND280S	250	355	12	26	250	355	12	26
FSCW 250/380	55			ND250M	250	355	12	26	250	355	12	26
FSCW 250/430	225			ND355L	300	410	12	26	250	355	12	26
FSCW 250/430	180/160			ND315LX/315L	300	410	12	26	250	355	12	26
FSCW 250/430	132			ND315M	300	410	12	26	250	355	12	26
FSCW 250/430	110			ND315S	300	410	12	26	250	355	12	26
FSCW 300/480	400			355ML	350	370	16	26	300	410	12	26
FSCW 300/480	335/275/250			ND355LX	350	370	16	26	300	410	12	26
FSCW 300/480	200			ND315LX	350	370	16	26	300	410	12	26
FSCW 350/560	710/560			400L	400	525	16	30	350	470	16	26
FSCW 350/560	500			355LK	400	525	16	30	350	470	16	26
FSCW 350/560	400			355ML	400	525	16	30	350	470	16	26
FSCW 350/560	335			ND355LX	400	525	16	30	350	470	16	26
FSCW 250/360	110			ND315S	250	355	12	26	250	355	12	26
FSCW 250/360	90			ND280M	250	355	12	26	250	355	12	26
FSCW 250/360	75			ND280S	250	355	12	26	250	355	12	26
FSCW 250/360	55			ND250M	250	355	12	26	250	355	12	26
FSCW 250/400	160			ND315LX	300	410	12	26	250	355	12	26
FSCW 250/400	132			ND315M	300	410	12	26	250	355	12	26
FSCW 250/400	110			ND315S	300	410	12	26	250	355	12	26
FSCW 250/400	75			ND280S	300	410	12	26	250	355	12	26
FSCW 300/450	315/275			ND355LX	350	470	16	26	300	410	12	26
FSCW 300/450	225			ND355L	350	470	16	26	300	410	12	26
FSCW 300/450	200/160			ND315LX	350	470	16	26	300	410	12	26
FSCW 400/510	630/560			400L	400	525	16	30	400	525	16	30
FSCW 400/510	450/400			355ML	400	525	16	30	400	525	16	30
FSCW 400/510	335			ND355LX	400	525	16	30	400	525	16	30
FSCW 450/560	900/800			450L	500	525	20	33	450	585	20	30
FSCW 450/560	710/560			400L	500	525	20	33	450	585	20	30
FSCW 450/560	500			355LK	500	525	20	33	450	585	20	30
FSCW 300/370	132			ND315M	300	410	12	26	300	410	12	26
FSCW 300/370	110			ND315S	300	410	12	26	300	410	12	26
FSCW 300/370	90			ND280M	300	410	12	26	300	410	12	26
FSCW 300/370	75			ND280S	300	410	12	26	300	410	12	26
FSCW 300/420	250			ND355LX	300	410	12	26	300	410	12	26
FSCW 300/420	225			ND355L	300	410	12	26	300	410	12	26
FSCW 300/420	132			ND315M	300	410	12	26	300	410	12	26
FSCW 300/420	200/160			ND315LX	300	410	12	26	300	410	12	26
FSCW 400/470	450			355ML	400	525	16	30	400	525	16	30
FSCW 400/470	360/315/275			ND355LX	400	410	16	30	400	410	16	30
FSCW 450/520	800			450L	500	525	20	33	450	585	20	30
FSCW 450/520	630/560			400L	500	525	20	33	450	585	20	30
FSCW 80/220			37/30	ND200L	100	180	8	18	80	160	8	18
FSCW 80/220			22	ND180M	100	180	8	18	80	160	8	18
FSCW 100/250			55	ND250M	125	210	8	18	100	180	8	18
FSCW 100/250			45	ND225M	125	210	8	18	100	180	8	18
FSCW 100/250			37/30	ND200L	125	210	8	18	100	180	8	18
FSCW 100/280			75	ND280S	125	210	8	18	100	180	8	18
FSCW 100/280			55	ND250M	125	210	8	18	100	180	8	18
FSCW 100/280			45	ND225M	125	210	8	18	100	180	8	18
FSCW 125/300			132	ND315M	150	240	8	22	125	210	8	18
FSCW 125/300			110	ND315S	150	240	8	22	125	210	8	18
FSCW 125/300			90	ND280M	150	240	8	22	125	210	8	18
FSCW 125/300			75	ND280S	150	240	8	22	125	210	8	18
FSCW 150/320			200/160	ND315LX	200	295	12	22	150	240	8	22
FSCW 150/320			180	ND315L	200	295	12	22	150	240	8	22
FSCW 150/320			132	ND315M	200	295	12	22	150	240	8	22
FSCW 350/530		250/225		ND355LX	400	525	16	30	350	470	16	26
FSCW 350/530		180		ND355L	400	525	16	30	350	470	16	26
FSCW 350/530		160		ND315LX	400	525	16	30	350	470	16	26
FSCW 350/530		132		ND315L	400	525	16	30	350	470	16	26

All Dimensions are in mm, unless otherwise specified.

In view of continuous development, the informations / descriptions / specification / illustration are subjected to change without notice.

PUMP SET DIMENSIONS

Pump General Dimension													Foundation Dimension								
A	B	C	D	E	F	G	H	I	J	K	M	N	L	L1	L2	L3	L4	P	Q	Z No's	S
570	675	800	1338	477.89	1475	812.5	1070	1584	8	3067	910	950	2600	100	800	800	800	20	250	8	26
570	675	800	1338	477.89	1475	812.5	1070	2187	8	3670	940	980	3300	105	1030	1030	1030	20	250	8	26
335	375	425	722	242	908.5	511	545	1035	5	1948.5	514	544	1485	80	662.5	662.5		20	100	6	18
335	375	425	722	242	908.5	511	545	940	5	1853.5	480	510	1435	80	637.5	637.5		20	100	6	18
335	375	425	722	242	908.5	511	545	865	5	1778.5	440	470	1385	80	612.5	612.5		20	100	6	18
335	375	425	722	242	908.5	511	545	840	5	1753.5	440	470	1350	80	595	595		20	100	6	18
380	425	465	812	244.8	1077	593.5	685	1180	5	2022	584	620	1900	100	850	850		20	200	6	18
380	425	465	812	244.8	1077	593.5	685	1085	5	2167	584	620	1900	100	850	850		20	200	6	18
380	425	465	812	244.8	1077	593.5	685	1035	5	2117	584	620	1700	100	750	750		20	200	6	18
380	425	465	812	244.8	1077	593.5	685	940	5	2022	584	620	1650	100	725	725		20	200	6	18
425	500	540	930.5	290.5	1077	593.5	760	1513	5	2595	654	690	2225	100	1012.5	1012.5		20	200	6	18
425	500	540	930.5	290.5	1077	593.5	760	1390	5	2472	654	690	2050	100	925	925		20	200	6	18
425	500	540	930.5	290.5	1077	593.5	710	1230	5	2312	654	690	2050	100	925	925		20	150	6	18
425	500	540	930.5	290.5	1077	593.5	710	1180	5	2262	654	690	1850	100	825	825		20	150	6	18
480	540	595	1029	319.22	1232	678.5	865	1584	5	2821	854	890	2400	150	700	700	700	20	250	8	22
480	540	595	1029	319.22	1232	678.5	865	1580	5	2817	854	890	2300	175	650	650	680	20	250	8	22
480	540	595	1029	319.22	1232	678.5	865	1390	5	2627	854	890	2150	175	600	600	600	20	250	8	22
600	650	705	1243	385.84	1475	812.5	975	1891	8	3374	990	1030	3000	105	930	930	930	20	250	8	26
600	650	705	1243	385.84	1475	812.5	975	1834	8	3317	990	1030	2900	100	900	900	900	20	250	8	26
600	650	705	1243	385.54	1475	812.5	975	1584	8	3067	990	1030	2600	100	800	800	800	20	250	8	26
600	650	705	1243	385.54	1475	812.5	975	1580	8	3063	990	1030	2650	100	817	817	817	20	250	8	26
400	450	510	850	290	1077	593.5	680	1180	5	2262	564	600	1900	100	850	850		20	150	6	18
400	450	510	850	290	1077	593.5	680	1085	5	2167	564	600	1820	100	810	810		20	150	6	18
400	450	510	850	290	1077	593.5	680	1035	5	2117	564	600	1800	100	800	800		20	150	6	18
400	450	510	850	290	1077	593.5	680	940	5	2022	564	600	1660	100	730	730		20	150	6	18
380	475	575	973	326	1077	593.5	795	1390	5	2472	584	620	2050	100	925	925		20	200	6	18
380	475	575	973	326	1077	593.5	795	1230	5	2312	584	620	1950	100	875	875		20	200	6	18
380	475	575	973	326	1077	593.5	795	1180	5	2262	584	620	1890	100	845	845		20	200	6	18
380	475	575	973	326	1077	593.5	795	1035	5	2117	584	620	1750	100	775	775		20	200	6	18
480	540	645	1088	366.39	1232	678.5	915	1580	5	2817	744	780	2400	150	700	700	700	20	250	8	22
425	525	645	1088	366.39	1232	678.5	865	1513	5	2570	744	780	2370	165	680	680	680	20	250	8	22
425	525	645	1088	366.39	1232	678.5	865	1390	5	2627	744	780	2250	150	650	650	650	20	250	8	22
600	600	720	1218	413.28	1232	678.5	990	1891	8	3131	820	860	2700	105	830	830	830	20	250	8	26
600	600	720	1218	413.28	1232	678.5	940	1584	8	2824	810	850	2400	105	730	730	730	20	200	8	26
600	600	720	1218	413.28	1232	678.5	940	1580	8	2820	810	850	2400	105	730	730	730	20	200	8	26
625	725	855	1378	477.95	1475	812.5	1125	2187	8	3670	940	980	3500	100	1100	1100	1100	20	250	8	26
625	725	855	1378	477.95	1475	812.5	1125	1891	8	3374	920	960	3000	105	930	930	930	20	250	8	26
625	725	855	1378	477.95	1475	812.5	1125	1834	8	3317	990	1030	3000	105	930	930		20	250	8	26
450	500	565	968	317.2	1077	593.5	785	1230	5	2312	674	710	1950	100	875	875		20	200	6	18
450	500	565	968	317.2	1077	593.5	785	1180	5	2262	674	710	1900	100	850	850		20	200	6	18
450	500	565	968	317.2	1077	593.5	785	1085	5	2167	674	710	1850	100	825	825		20	200	6	18
450	500	565	968	317.2	1077	593.5	785	1035	5	2117	674	710	1800	100	800	800		20	200	6	18
500	550	640	1088	362.56	1232	678.5	910	1580	5	2817	774	810	2400	150	700	700	700	20	250	8	22
500	550	640	1088	362.56	1232	678.5	910	1513	5	2750	774	810	2370	165	680	680	680	20	250	8	22
500	550	640	1088	362.56	1232	678.5	860	1230	5	2467	834	870	2100	150	600	600	650	20	200	8	22
500	550	640	1088	362.56	1232	678.5	860	1390	5	2627	834	870	2150	175	600	600	830	20	200	8	22
600	625	715	1213	407.5	1232	678.5	935	1584	8	2824	910	950	2450	100	750	750	730	20	200	8	26
600	625	715	1213	407.5	1232	678.5	935	1580	8	2820	910	950	2450	100	750	750	730	20	200	8	26
650	750	900	1458	505	1475	812.5	1170	2187	8	3670	980	1020	3500	100	1100	1100	1100	20	250	8	26
650	750	900	1458	505	1475	812.5	1170	1891	8	3374	980	1020	3000	105	930	930	930	20	250	8	26
225	225	265	444	141.2	616.5	350	385	790	5	1411.5	364	400	1130	100	465	465		20	100	6	18
225	225	265	444	141.2	616.5	350	360	677	5	1298.5	350	380	990	100	395	395		20	75	6	14
220	250	305	518	167.9	833.5	350	425	940	5	1778.5	424	460	1270	100	535	535		20	100	6	18
220	250	305	518	167.9	833.5	350	425	865	5	1703.5	424	460	1190	100	495	495		20	100	6	18
220	250	305	518	167.9	833.5	350	425	790	5	1628.5	424	460	1120	100	460	460		20	100	6	18
250	275	325	556	184	933.5	450	495	1035	5	1973.5	514	550	1540	100	670	670		20	150	6	18
250	275	325	556	184	933.5	450	445	940	5	1878.5	444	480	1400	100	600	600		20	100	6	18
250	275	325	556	184	933.5	450	445	865	5	1803.5	424	460	1300	100	550	550	550	20	100	6	18
300	300	350	587	190.49	908	511	520	1230	8	2146	574	610	1850	100	550	550	550	20	150	8	22
300	300	350	587	190.49	908	511	520	1180	8	2096	574	610	1850	100	550	550		20	150	8	22
300	300	350	587	190.49	908	511	520	1085	8	2001	574	610	1650	100	725	725		20	150	6	18
300	300	350	587	190.49	908	511	520	1035	8	1951	574	610	1650	100	725	725		20	150	6	18
330	350	410	692	228	908	511	630	1390	5	2303	584	620	1900	100	850	850		20	200	6	18
330	350	410	692	228	908	511	630	1295	5	2208	584	620	1850	100	825	825		20	200	6	18
330	350	410	692	228	908	511	630	1230	5	2143	584	620	1800	100	800	800		20	200	6	18
525	725	770	1313	450.6	1325	725	1040	1580	5	2910	880	916	2370	100	1085	1085		20	250	6	18
525	725	770	1313	450.6	1325	725	1040	1513	5	2843	880	916	2460	100	1130						

NOTES

A series of horizontal dotted lines for writing notes, starting from the top of the page and extending downwards.

NOTES

A series of horizontal dotted lines for writing notes, starting from the top of the page and extending downwards.



FABBRICA ITALIANA POMPE SOMMERGIBILI S.r.l.

Via dell' Artigianato,16 - 20090 Pieve Emanuele (MI)-Italy
Tel. + 39 (0) 2 49708488 | Fax +39 (0) 2 37908126
E-mail: info@fips-pumps.it | www.zirantec.com

FIPS MIDDLE EAST (FZC)

(A Subsidiary of Fabbrica Italiana Pompe Sommergibili S.r.l - Italy)
SAIF ZONE, Sharjah, UAE, Tel : +971 - 564060250
E-mail: info@fips-pumps.it | www.zirantec.com